

Drilling tool holder HSK 40 A DIN 1835 B

Technische Daten

Shank HSK	HSK 40
Form HSK	A
Mounting	DIN 1835 B/E D5
Cooling	internal
Pressure	80 bar
X [mm]	45.5 (1.79")
INDEX TRAUB products	G160 • V100 • G200.2 • R200 • TNX65/42 • G220.3 • TNX220.3

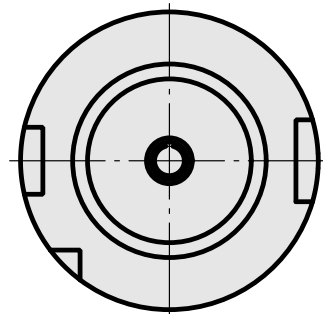
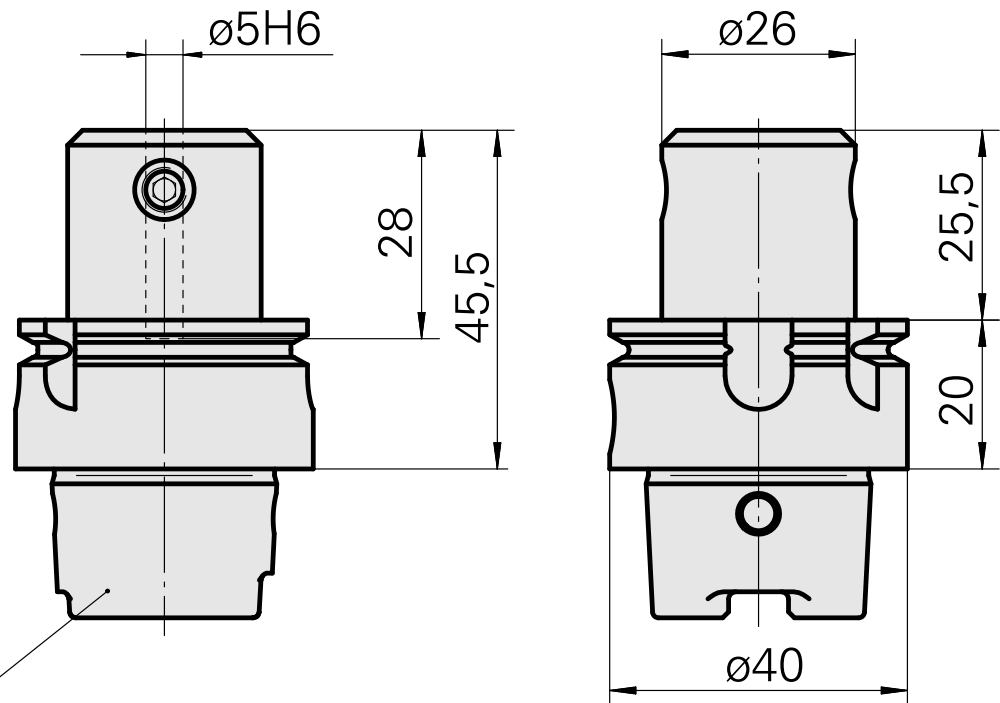

Dokumente

Für dieses Produkt sind keine Downloads vorhanden

Zubehör

Zum Betrieb benötigt

Socket wrench

Artikel-Id : 10532354
frühere Artikel-Id : WS7400.0010

TH accessories category Tool for KSS adapter	Mounting HSK 40 A/C
--	------------------------

Optionales Zubehör

Tool holder accessories

Coolant adapter kit

Artikel-Id : 10581780
frühere Artikel-Id : WS7400.0020

WZH Zubehörkategorie Kühlschmierstoff- Übergabesatz	Aufnahme HSK 40 A/C
---	------------------------

Coolant supply, max. 120 bar

Artikel-Id : 12024083
frühere Artikel-Id :

WZH Zubehörkategorie Kühlschmierstoff- Übergabesatz	Aufnahme HSK 40 A/C
---	------------------------