

WFB 32-20 ER25

Technical data

TH accessories category

WFB 32-20

Mounting

ER25

Quick change inserts

collet mounting

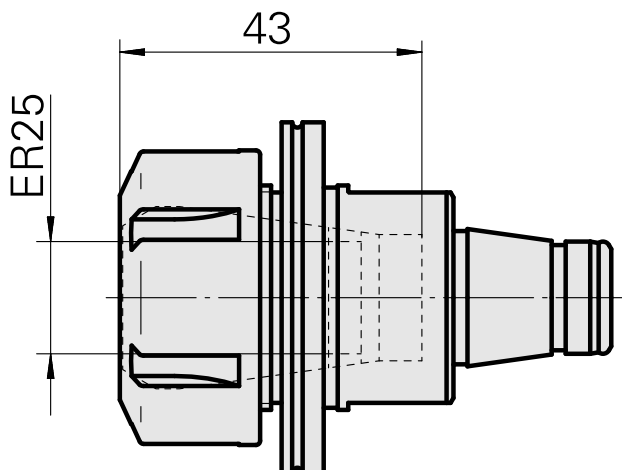
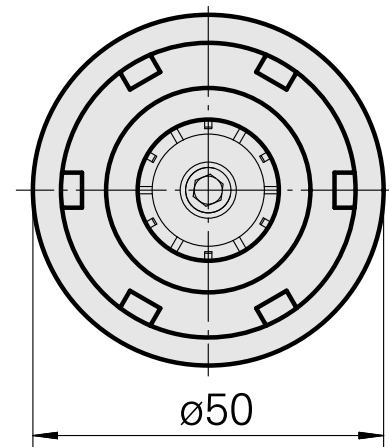
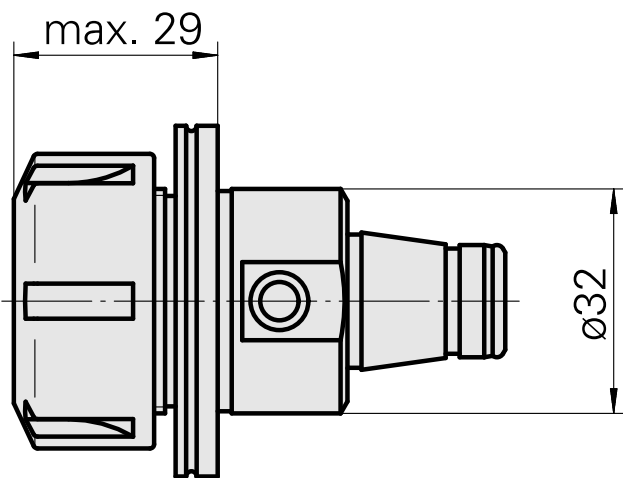
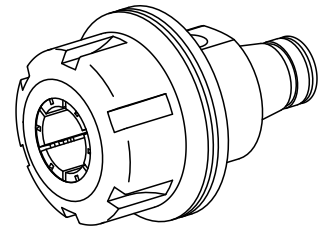

Documents

No downloads available for this product

Accessories

Required for operation

[Spanner](#)

Product ID : 10802433

Previous product ID : 490219.0251

TH accessories category Tool	Mounting ER25	Collet type ER 25	Clamping nut type Female thread
Tools for Collet chucks Clamping nut wrench			

Optional accessories

Tool holder accessories

[Clamping nut](#)

Product ID : 10193990

Previous product ID : 901939.0251

TH accessories category Clamping nut	Mounting ER25	Collet type ER 25	Clamping nut type Female thread
---	------------------	----------------------	------------------------------------

Other accessories

[Clamping collet](#)

Product ID : 10206464

Previous product ID : 901930.3---

[tapping tool collet ET-1-25](#)

Product ID : 10191234

Previous product ID : 3224--

10496422
W9990298

INDEX

[tapping tool collet](#)

Product ID : 10256515
Previous product ID : WZ9990.9507F

[Collet chuck](#)

Product ID : 10029756
Previous product ID : W999067-

[Clamping collet, sealed](#)

Product ID : 10698406
Previous product ID : W999085-
