

Guide bush T223 Ø=12,00

Technical data

Clamping device size manufacturer product line	T223 deadlength
Clamping type	with carbide insert
Nominal diameter (mm)	12 Millimeter
Clamping method	External clamping
Collet design	programmable (Axfix)
Collet version	Slots vulcanized (standard)
manufacturer product line	Schlenker

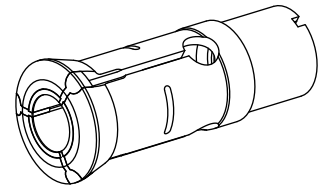

Note

with bushing



Documents

No downloads available for this product