

Führungsbuchse T223 Ø=17,00

Technische Daten

Spannmittelbaugröße	T223
Hersteller Produktlinie	Führungsbuchse
Spannausführung	mit HM-Einsatz
Nenn Durchmesser	17 Millimeter
Spannmethode	Außenspannung
Spannzangenausführung	einstellbar
Spannzangenvariante	Schlitze vulkanisiert (Stdrd)
Hersteller Produktlinie	Schlenker

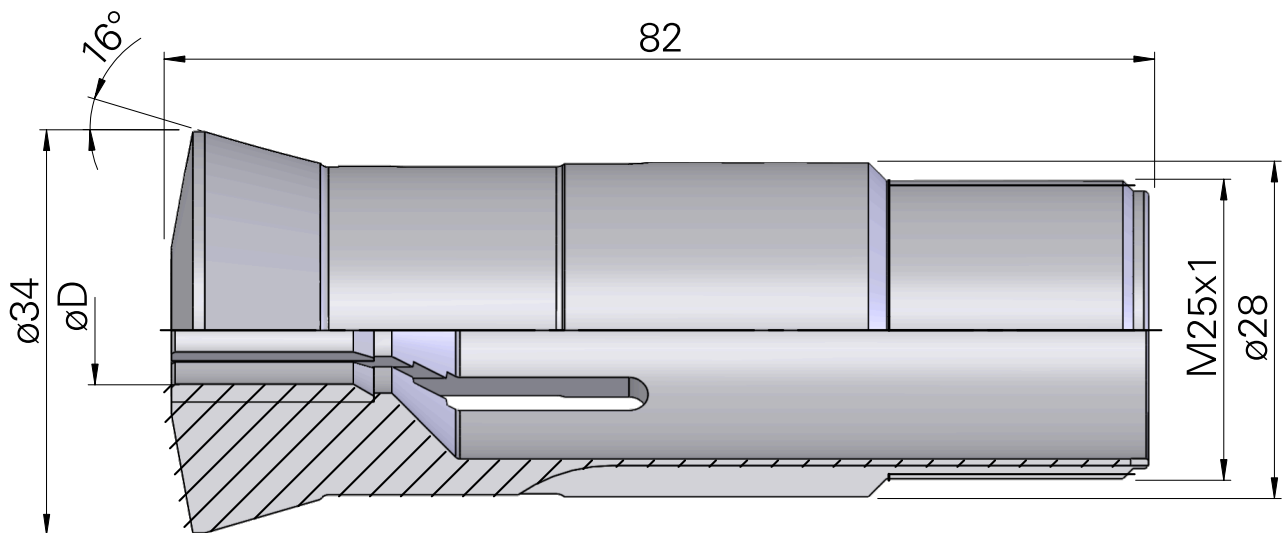

Dokumente

Für dieses Produkt sind keine Downloads vorhanden