

WFB 20-12 for DC.. 11T3.., right, without gripper groove

Technical data

TH accessories category

WFB 20-12

Mounting

for DC.. 11T3..

Quick change inserts

Turning tool holder

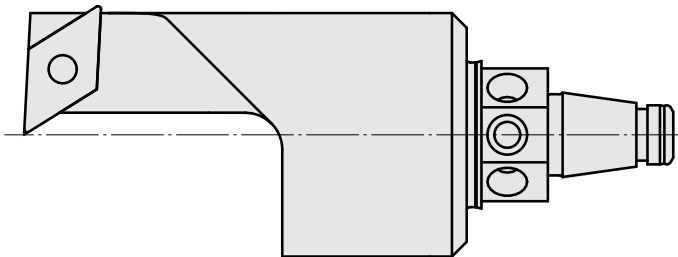
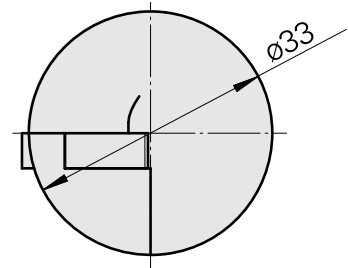
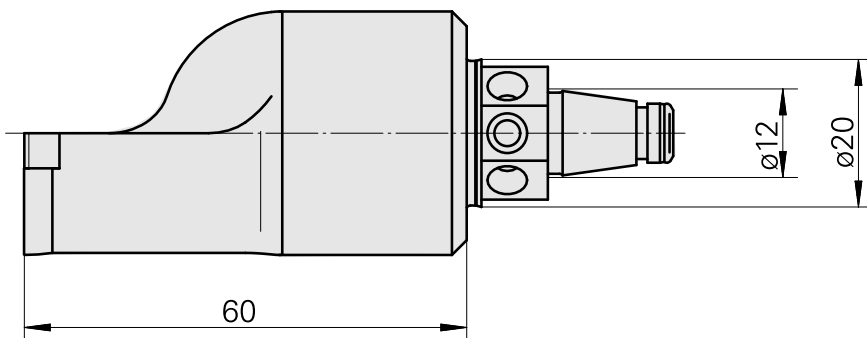
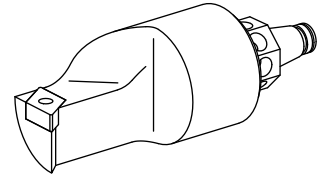

Documents

No downloads available for this product