

Drilling tool holder VDI 40 MK2

Technical data

Shank VDI	VDI 40
Drive	not live
Fixation VDI	none
Cooling	internal
Pressure	20 bar
Mounting	MK2
reversible 180°	no
X [mm]	36 (1.42")
Y [mm]	–
Z [mm]	–
INDEX TRAUB products	V200 • V160C • V160G • V300 • TNA400 • B400 • B500 • TNA500.2 • TNA400.2 • TNA400.3 • B400.3 • B500.3 • TNA500.3

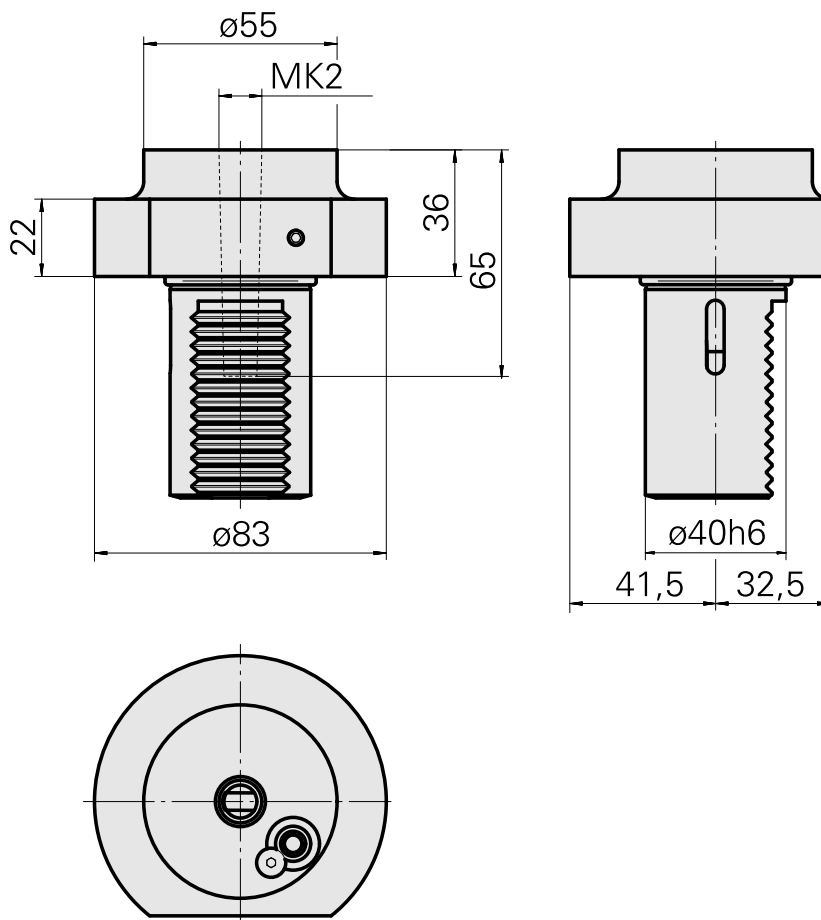
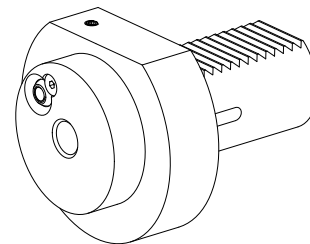

Documents

No downloads available for this product