

---

## Center holder D15.4/Cone 1:7.5, elastic, live

### Technical data

<b>Drive</b>	not live
<b>Fixation MS</b>	Clamping ring D36
<b>Mounting</b>	D15.4/Cone 1:7.5
<b>X [mm]</b>	–
<b>Y [mm]</b>	–
<b>Z [mm]</b>	–
<b>INDEX TRAUB products</b>	MS32C • MS52C • MS32-6.2 • MS40-6 • MS40-8 • MS52-6.3 • MS32-6.3



### Note

Spring travel 4.5 mm, Yellow ring 0 - 1600 N, Green ring 1600 - 2100 N, Red ring 2100 - 3000 N

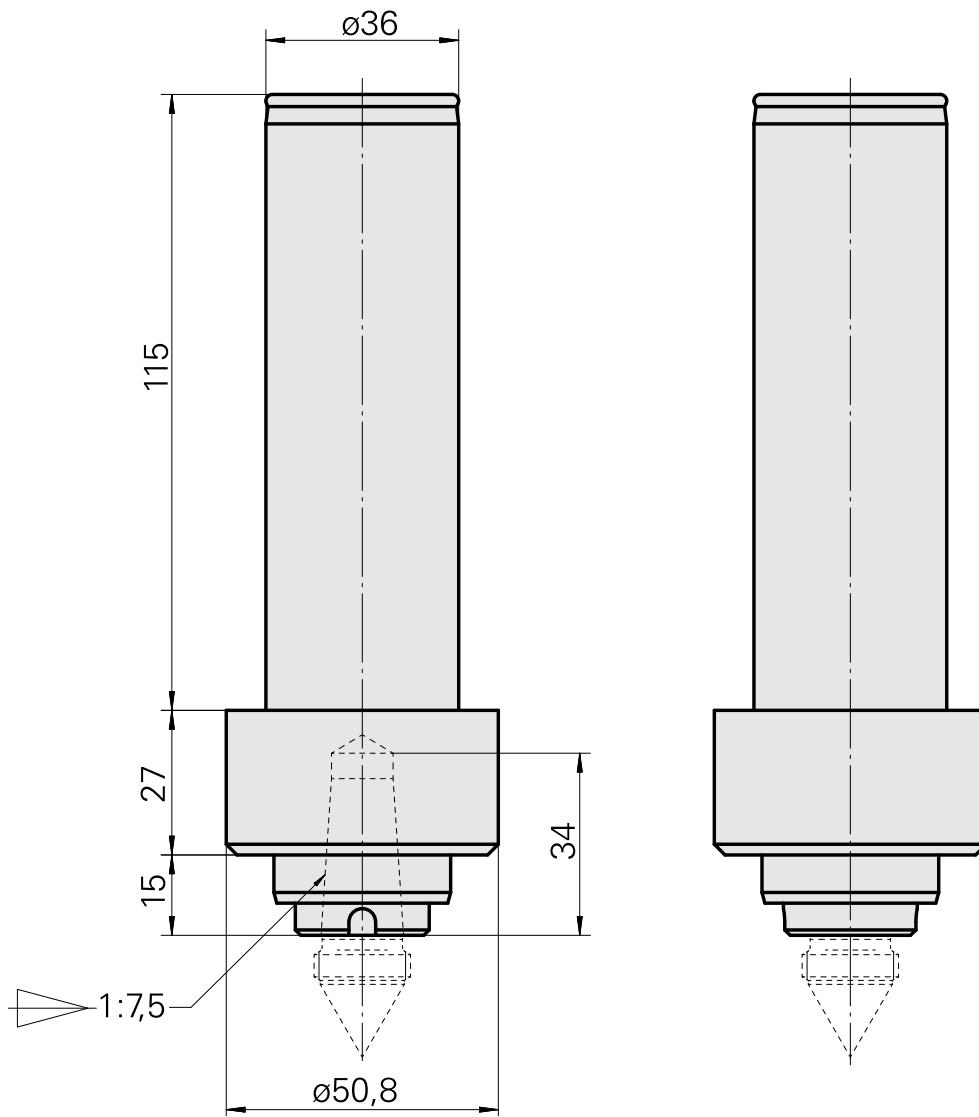

## **Documents**

No downloads available for this product

## **Accessories**

Optional accessories

**Other accessories**

[Center Kegel 1:7.5](#)

Product ID : 10606287

Previous product ID : W9636-.21--

---