

Portafresa HSK 25 C Albero portafrese D8

Caratteristiche tecniche

Gambo HSK	HSK 25
Forma HSK	C
Attacco	Albero portafrese D8
Raffreddamento	interno
Pressione	40 bar
X [mm]	24
Prodotti INDEX TRAUB	MS22-6 • MS22-8 • MS16-6

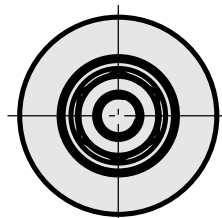
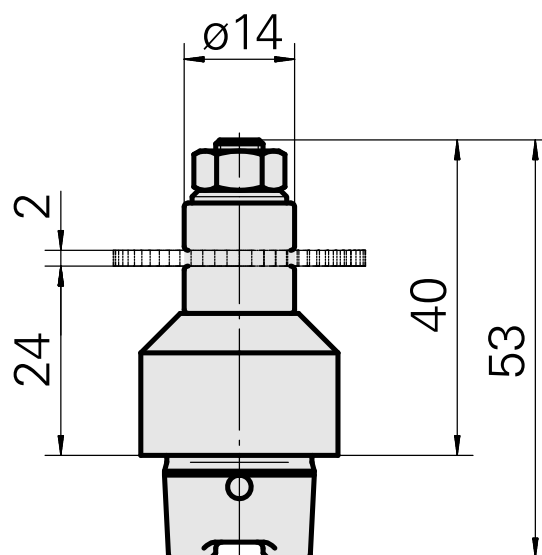
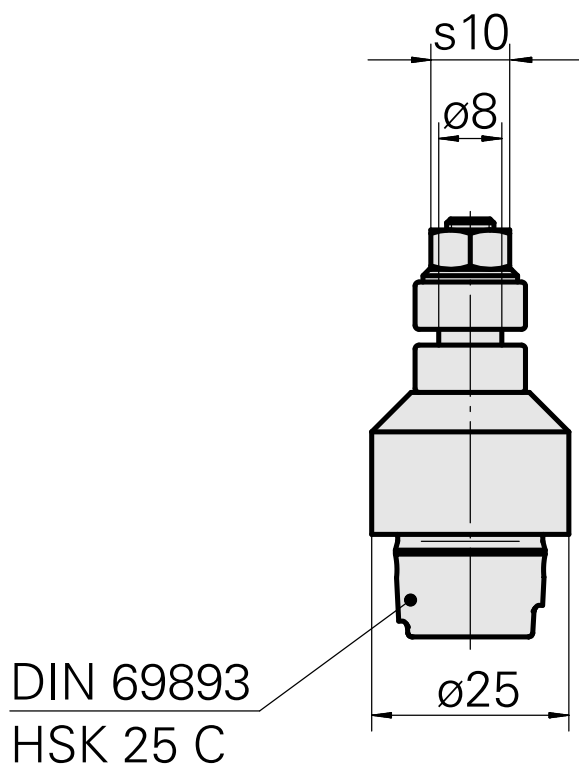
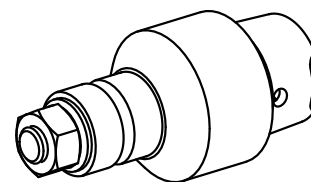

Documenti

Non sono disponibili download per questo prodotto