

Portapunte HSK 25 C DIN 1835 B/E D6

Caratteristiche tecniche

Gambo HSK	HSK 25
Forma HSK	C
Attacco	DIN 1835 B/E D6
Raffreddamento	interno
Pressione	40 bar
X [mm]	42
Prodotti INDEX TRAUB	MS22-6 • MS22-8 • MS16-6

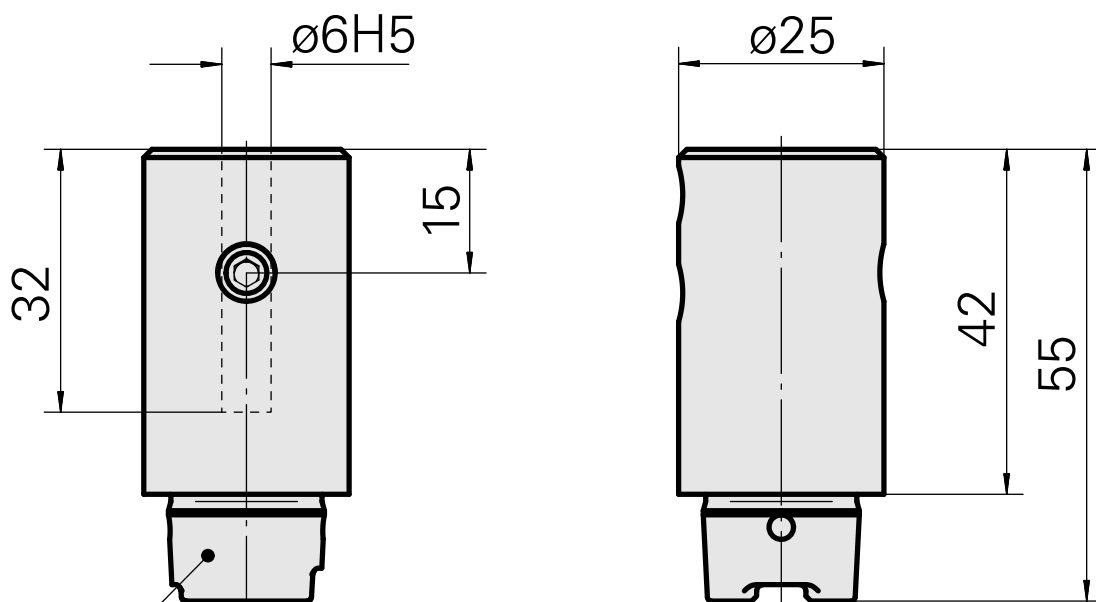
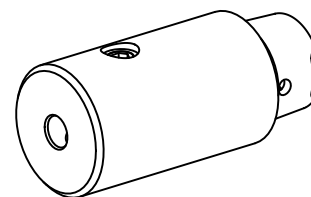

DIN 69893
HSK 25 C

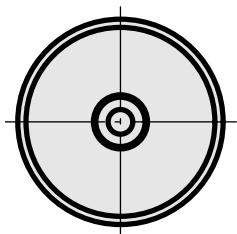

Documenti

Non sono disponibili download per questo prodotto