

## Boring head for DN.. 1506..

### Technical data

<b>Mounting</b>	for DN.. 1506..
<b>Cooling</b>	internal
<b>Pressure</b>	50 bar
<b>X [mm]</b>	36 (1.42")
<b>Z [mm]</b>	35 (1.38)
<b>INDEX TRAUB products</b>	G220 • G420 • G520 • G320.2 • G220.3 • TNX220.3

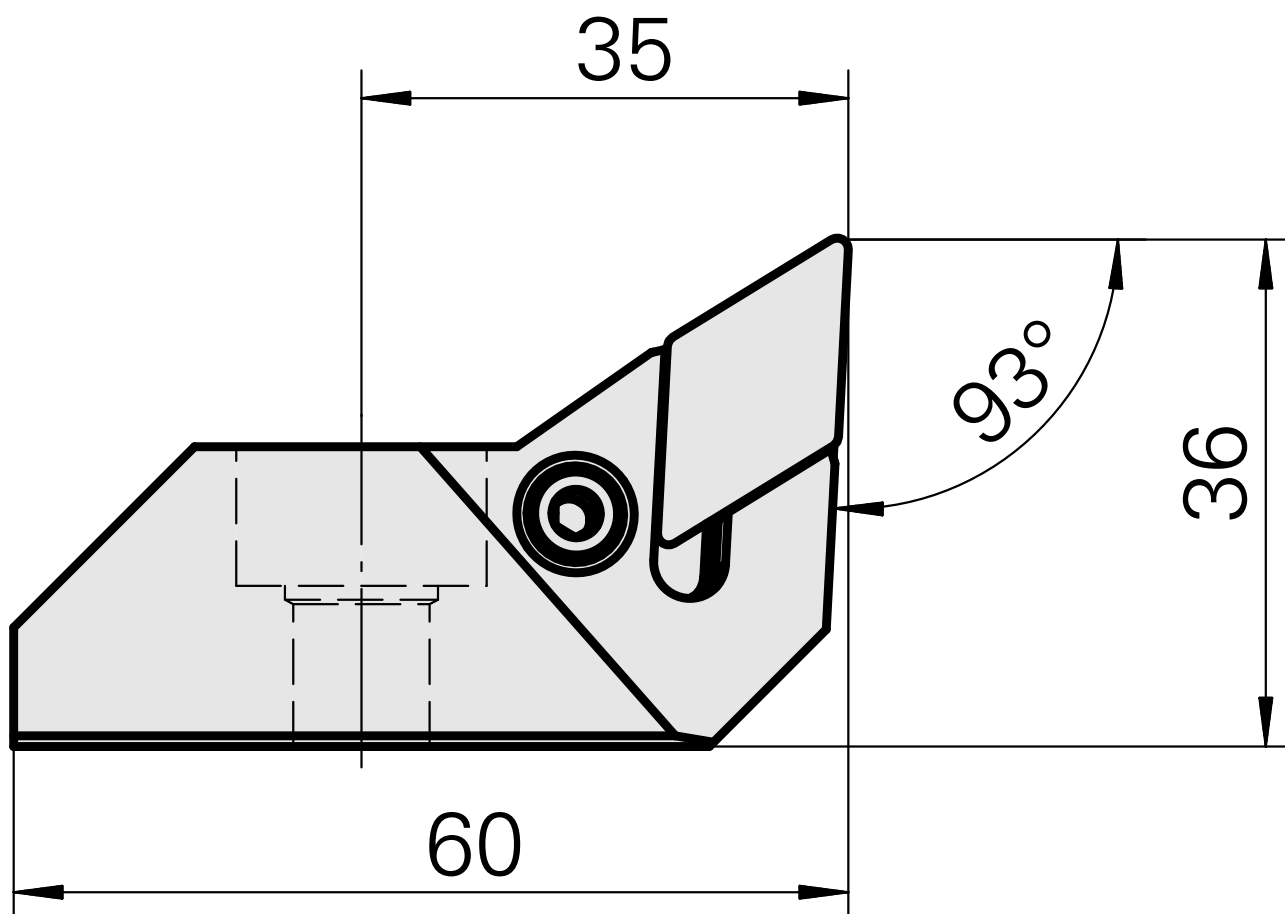
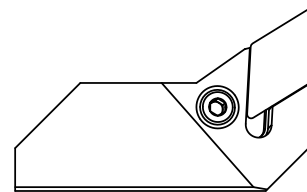

## **Documents**

No downloads available for this product