

## Turning tool holder VDI 20 square 3/4"x3, Form C1/C4

### Technical data

<b>Shank VDI</b>	VDI 20
<b>Drive</b>	not live
<b>Fixation VDI</b>	W serration
<b>Cooling</b>	external
<b>Pressure</b>	20 bar
<b>Mounting</b>	Square 3/4"x3/4"
<b>reversible 180°</b>	yes
<b>X [mm]</b>	55 (2.17")
<b>Y [mm]</b>	—
<b>Z [mm]</b>	32 (1.26)
<b>INDEX TRAUB products</b>	C100

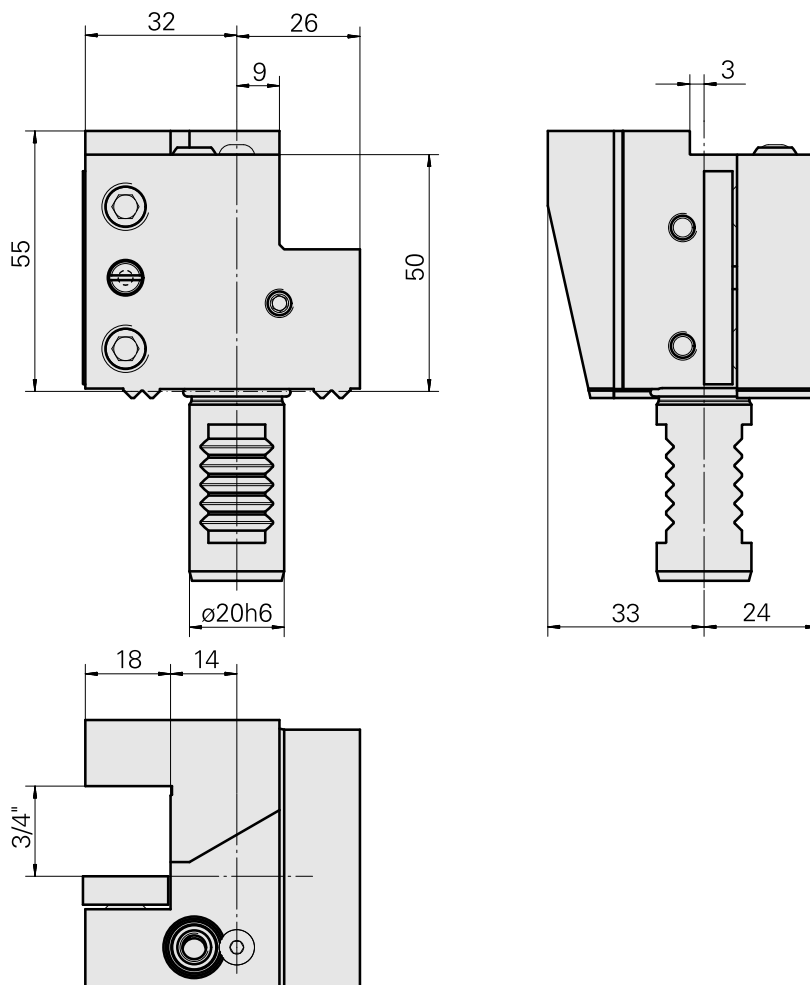
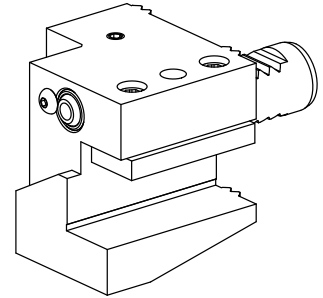

## Documents

No downloads available for this product

## Accessories

Optional accessories

### Other accessories

#### [Seal](#)

Product ID : 10478680

Previous product ID : W67221.4196

---

#### [Blanking plug D12](#)

Product ID : 10532667

Previous product ID : W00015.0021

---

#### [BALL SPRAY NOZZLE 12D/M6](#)

Product ID : 10602750

Previous product ID : 474550.0101

---

#### [Lens head screw](#)

Product ID : 10344546

Previous product ID : 410243.0406

---