

WFB 32-20 D25

Technical data

TH accessories category	WFB 32-20
Mounting	D25
Quick change inserts	Weldon mounting

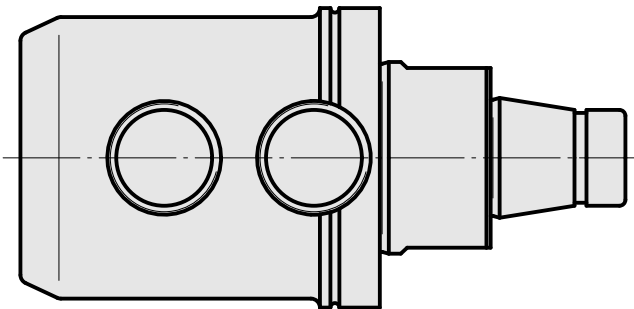
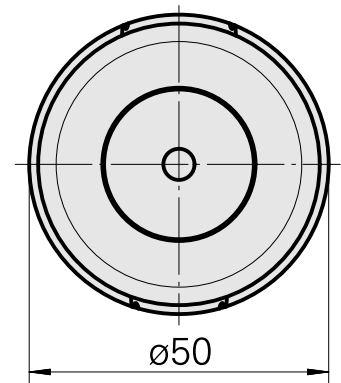
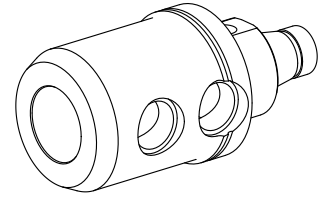

Documents

No downloads available for this product

Accessories

Optional accessories

Other accessories

[Mounting sleeve with collar D25](#)

Product ID : 10070544

Previous product ID : W62221.41--
