

Centering drill, center 60°

Technical data

TH accessories category

Center, universal

Mounting

D15.4/Cone 1:7.5

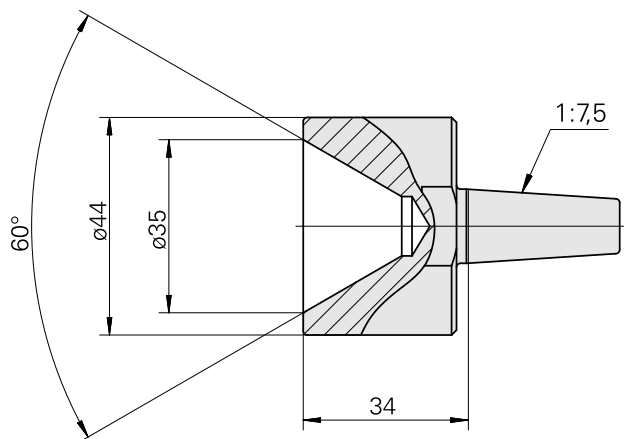
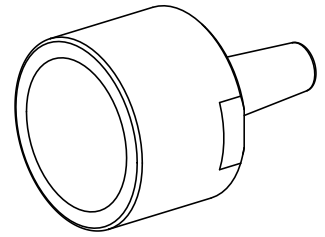

Documents

No downloads available for this product