

Saw blade, circular saw blade width 2 mm (0.07")

Technical data

TH accessories category

Circular saw blade d50

Tool mounting

13mm

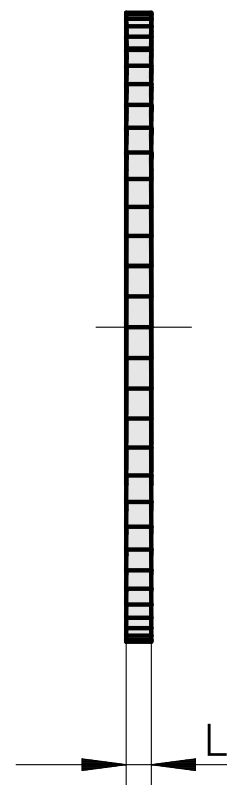
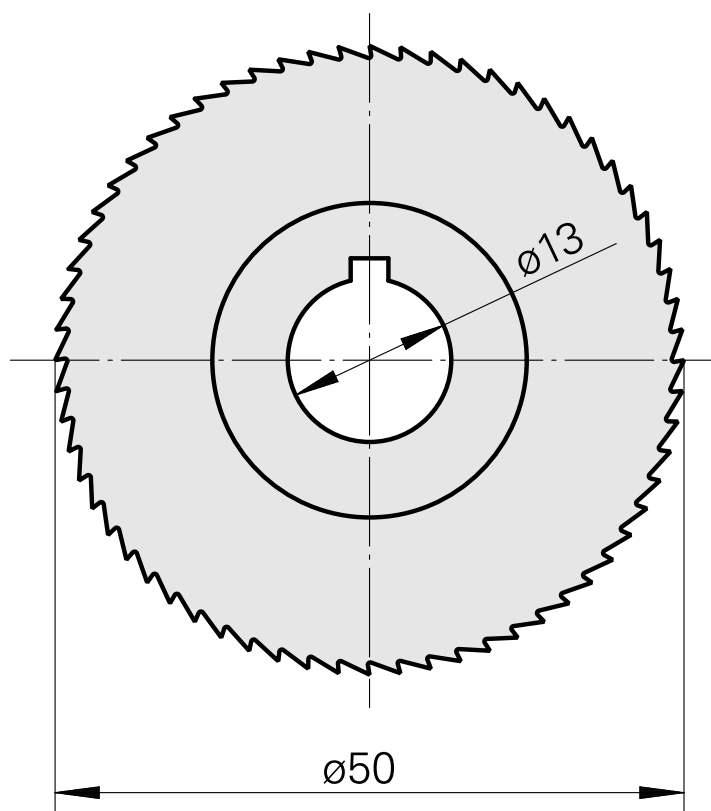
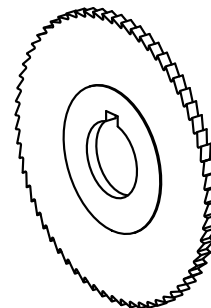

Documents

No downloads available for this product