

Ponta do centrador, 60° D44 mm para corpo oco

Características técnicas

PF Categoria de acessórios

Ponta guia, universal

Recepção

D15,4/Cone 1:7,5

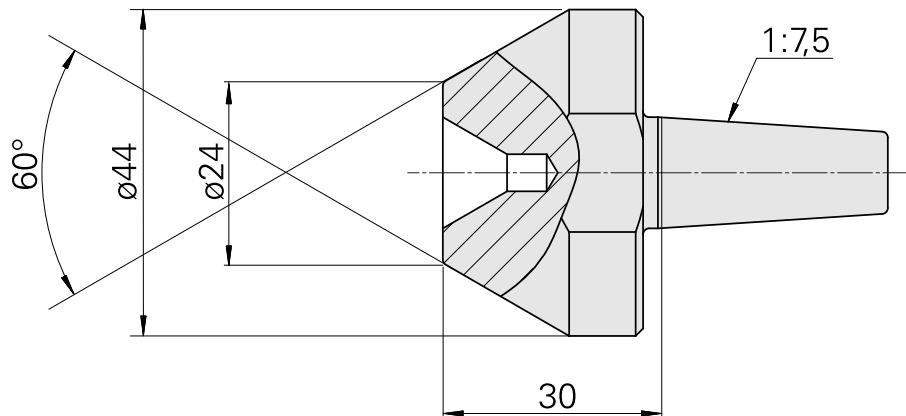
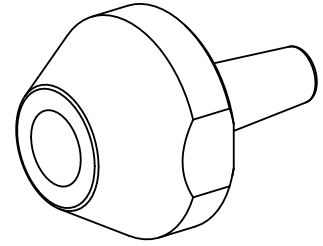

Documentos

Não há downloads disponíveis para este produto