

WFB 32-20 Hydraulic expansion chuck D8

Technical data

TH accessories category

WFB 32-20

Mounting

Hydraulic expansion chuck D8

Quick change inserts

hydraulic expan. mounting

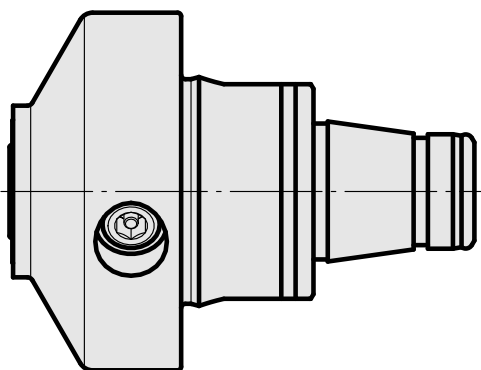
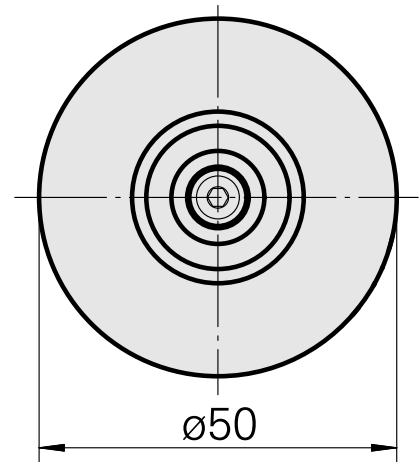
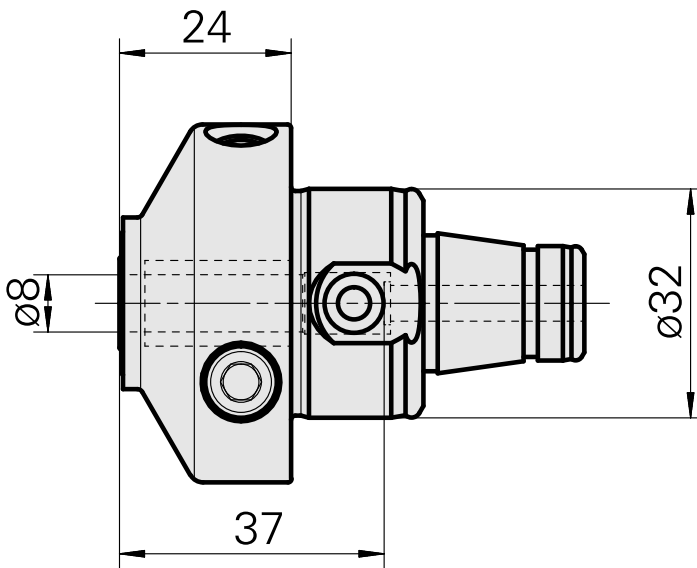
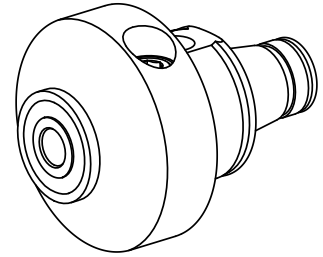

Documents

Product notes

[DE \(pdf\)](#)

[EN \(pdf\)](#)

[FR \(pdf\)](#)