

## 钻头刀架 D16

### 技术特点

驱动装置	非动力式
固定装置MS	锁紧环 D28,5
冷却	内冷
压力	80 bar
夹具	D16
X [mm]	-
Y [mm]	-
Z [mm]	-
INDEX TRAUB产品	A100 • MS16-6 • MS22-6 • MS22-8 • MS24-6 • MS16-6 Plus

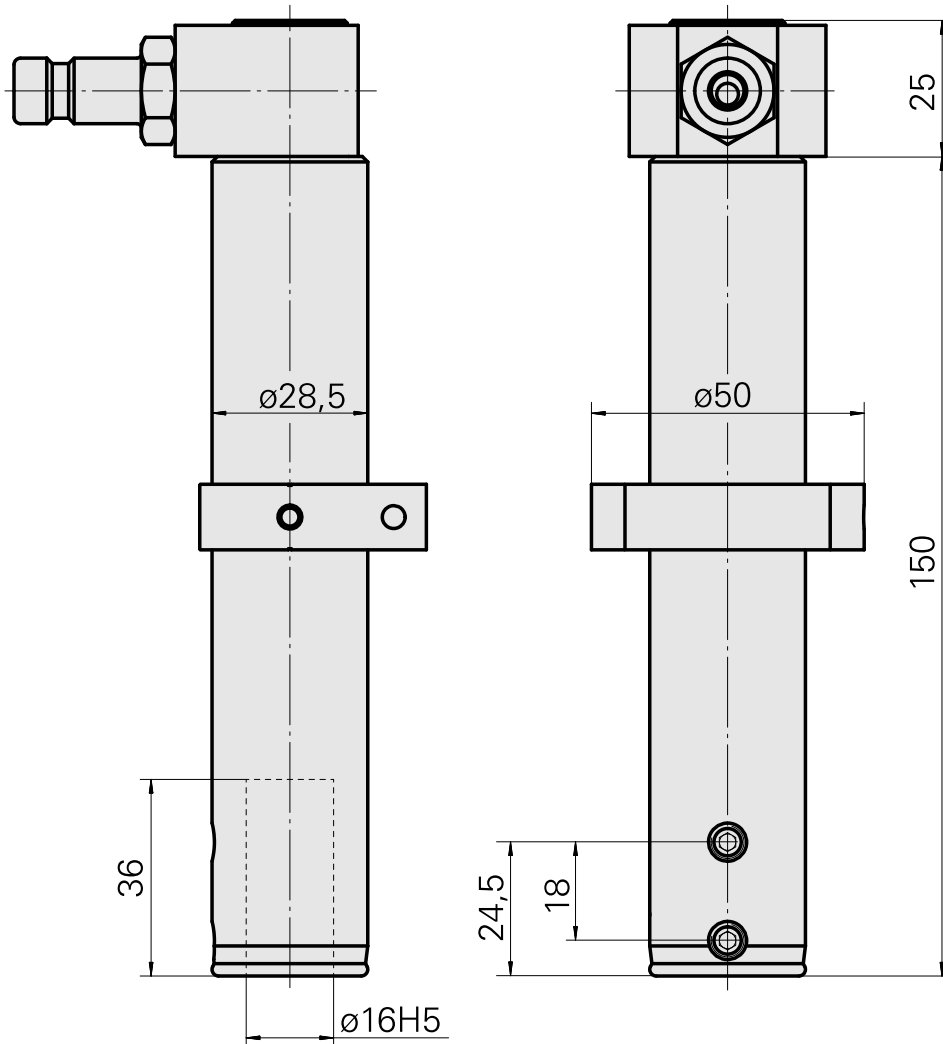
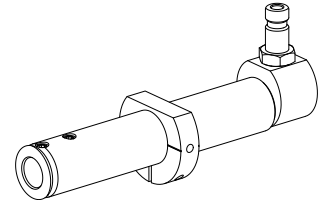

---

## 文件

没有针对此产品的任何下载

## 附件

### 可选附件

其他附件

#### [带肩安装套 D16](#)

产品ID：10914323

以前的产品ID：W67511.04--

---

#### [Clutch SP-006-0-WR513-11-2 Serie LP](#)

产品ID：10837142

以前的产品ID：474940.0112

---

#### [Nipple SP-006-1-WR013-11 Serie LP](#)

产品ID：10186287

以前的产品ID：474946.25

---