

## Drilling tool holder Shank 40 D16 (0.63)

### Technical data

<b>Shank TNL</b>	Shank 40
<b>Drive</b>	not live
<b>Cooling</b>	internal
<b>Pressure</b>	120 bar
<b>Mounting</b>	D16
<b>INDEX TRAUB products</b>	TNK36 • TNL26

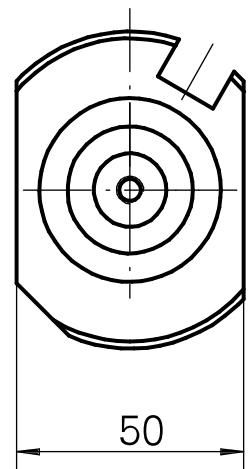
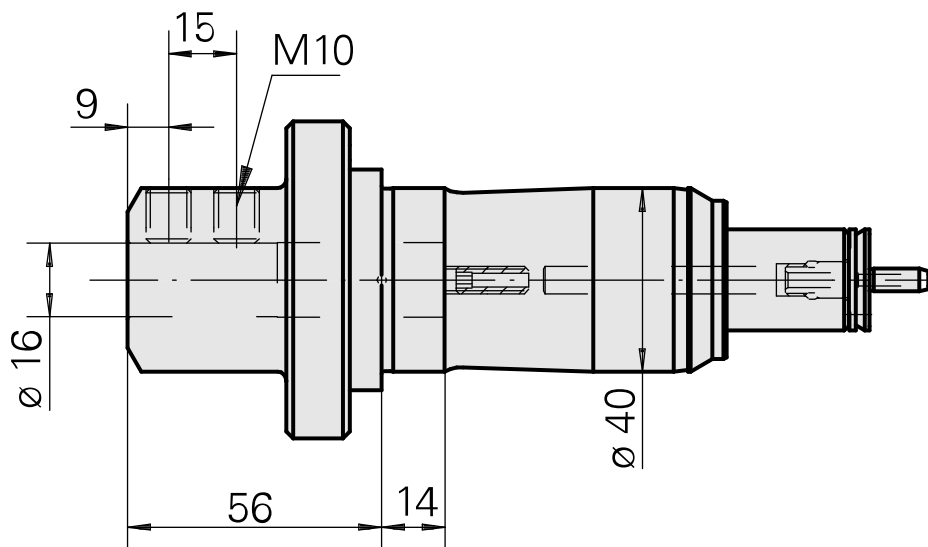
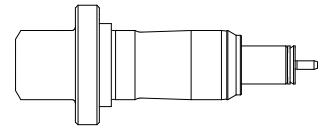

10117266  
984510

**INDEX**

---

## **Documents**

No downloads available for this product