

WFB 20-12 D4

Technical data

TH accessories category

WFB 20-12

Mounting

D4

Quick change inserts

Weldon mounting

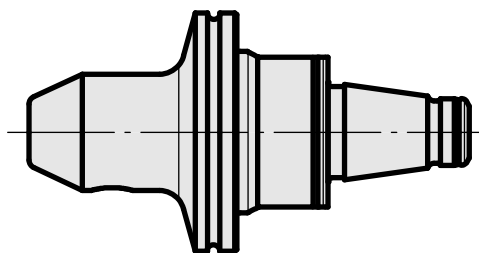
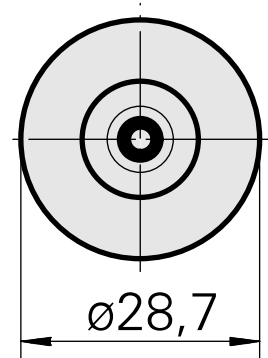
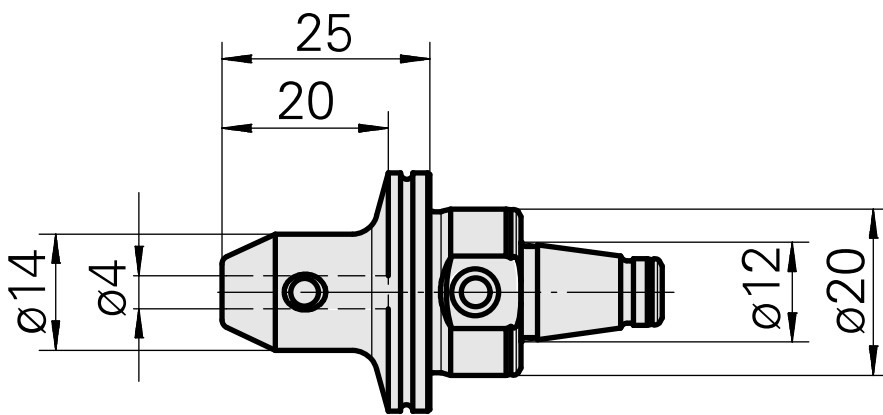
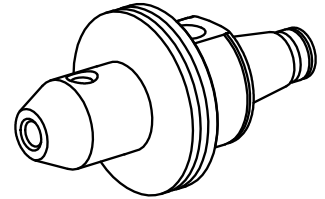

Documents

No downloads available for this product