

Pinza di serraggio 1212E/F16 Ø=10,00

Caratteristiche tecniche

Altezza mont. sistema serr.	1212E/F16
Lin. prod. di altri produkt.	
Tipo di serraggio	scanalato
Diametro nominale (mm)	10 Millimeter
Metodo di serraggio	Serraggio esterno
Lin. prod. di altri produkt.	Schlenker

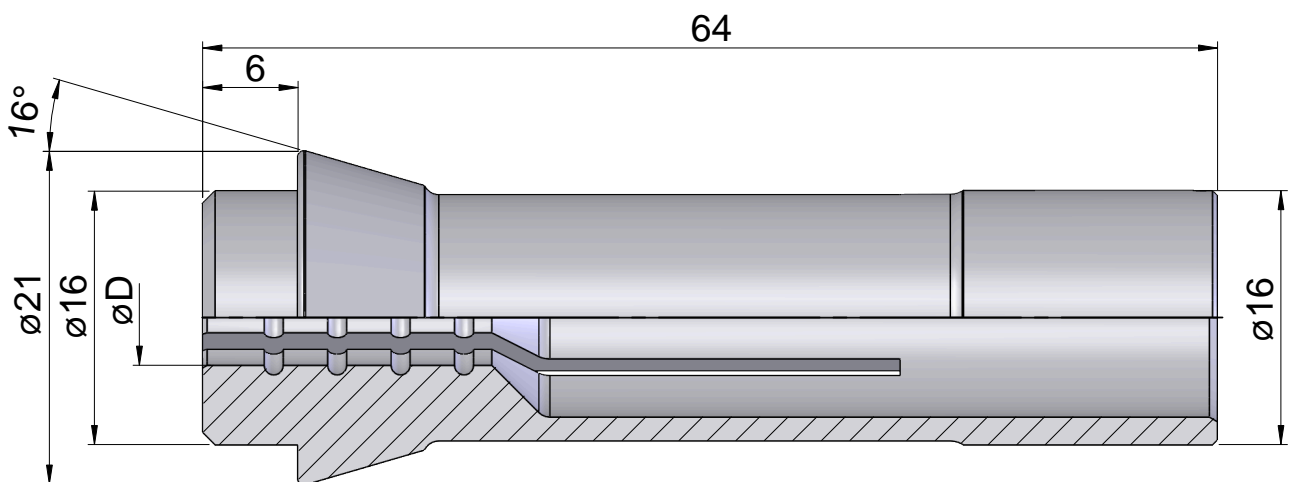

Documenti

Non sono disponibili download per questo prodotto