

Guide bush T223 Ø=14,00

Technical features

Clamping device size	T223
Ext. manufacturer product line	
Clamping type	with carbide insert
Nominal diameter (mm)	14 Millimeter
Clamping method	External clamping
Collet design	adjustable
Collet version	S-slot
Ext. manufacturer product line	Schlenker

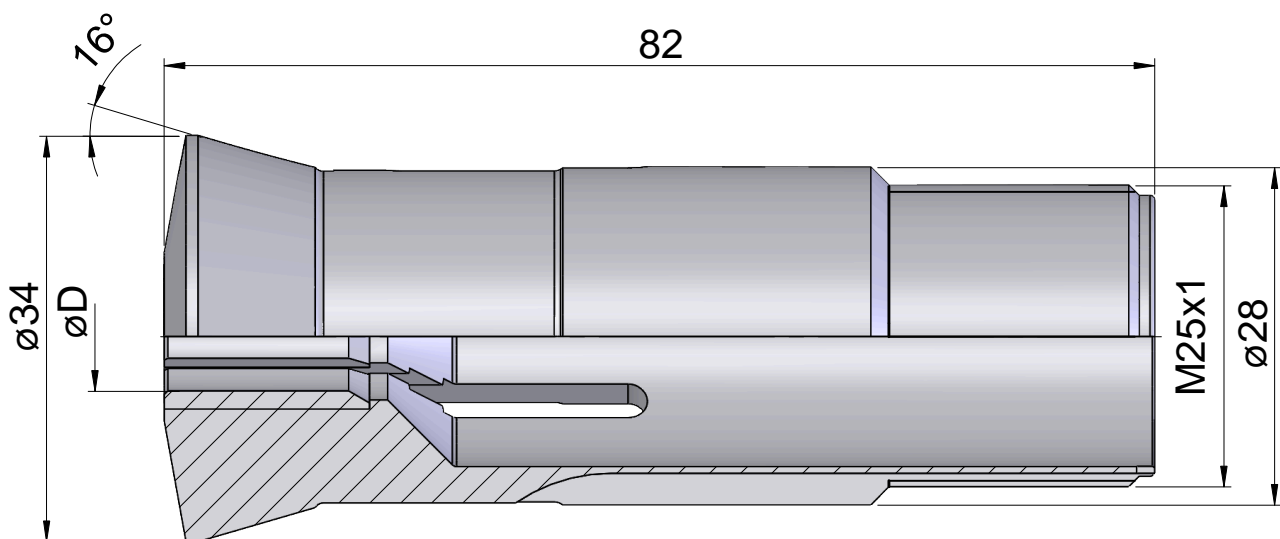
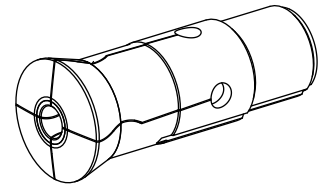

Documents

No downloads available for this product