

Clamping head SK42 D=19,0mm

Technical data

Clamping device size	SK42
manufacturer product line	SPANNTOP nova chuck
Clamping type	grooved
Nominal diameter (mm)	19 Millimeter
Clamping method	External clamping
manufacturer product line	Hainbuch

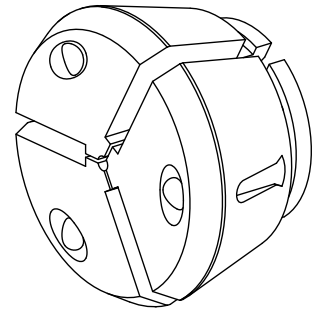

No 3-side view is currently available for this product

11056432
900463.4219

INDEX

Documents

No downloads available for this product