

## Drilling tool holder D8

### Technical data

<b>Drive</b>	not live
<b>Fixation MS</b>	Clamping ring D36
<b>Cooling</b>	internal
<b>Pressure</b>	80 bar
<b>Mounting</b>	D8
<b>X [mm]</b>	-
<b>Y [mm]</b>	-
<b>Z [mm]</b>	-
<b>INDEX TRAUB products</b>	MS32C • MS52C • MS32-6.2 • MS40-6 • MS40-8 • MS52-6.3 • MS32-6.3

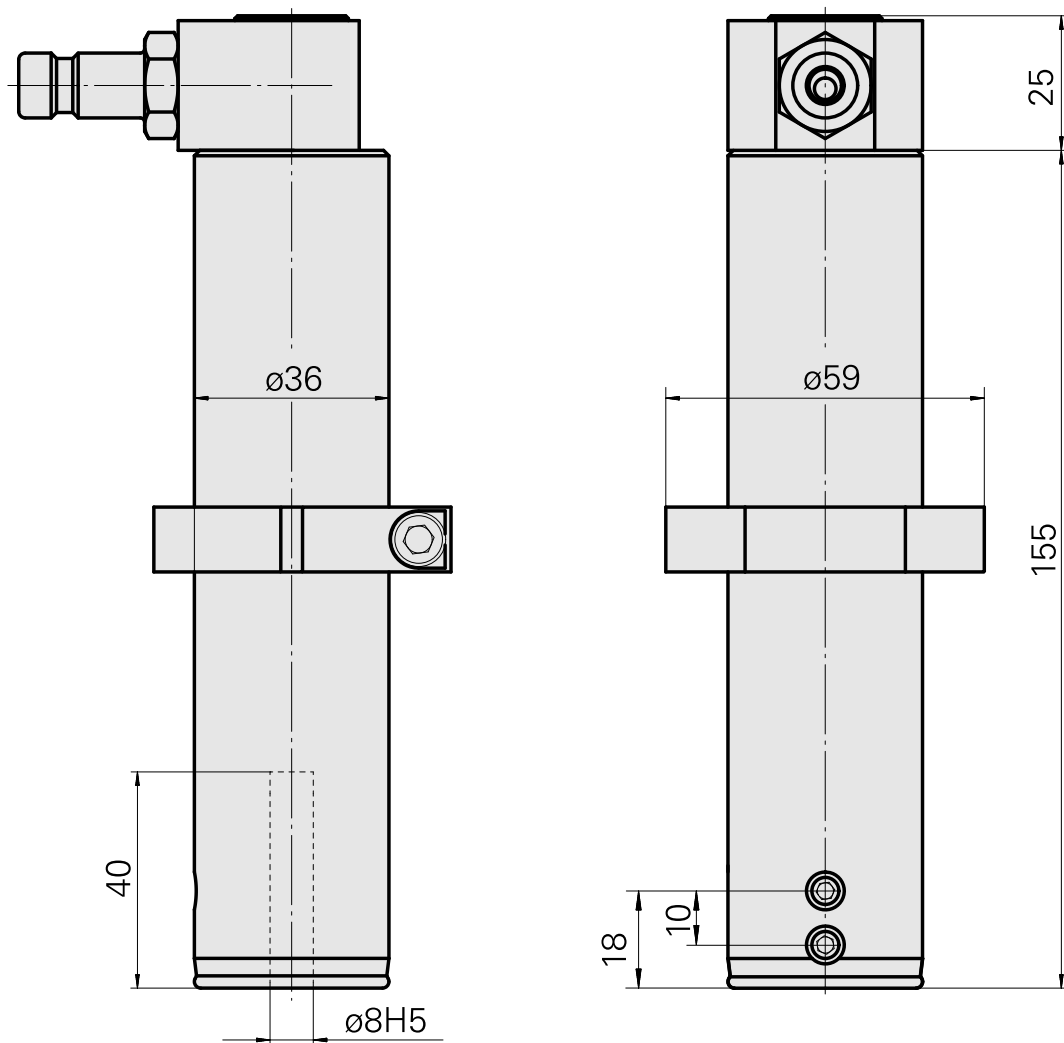
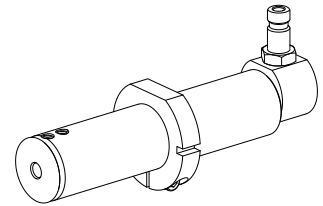

## Documents

No downloads available for this product

## Accessories

Optional accessories

### Other accessories

#### [QUICK COUPLING SP-006-0-WR513-11-2 Serie LP](#)

Product ID : 10837142

Previous product ID : 474940.0112

---

#### [QUICK DISCONNECT FITTING SP-006-1-WR013-11 Serie LP](#)

Product ID : 10186287

Previous product ID : 474946.25

---