

## Milling unit Circular prism 2:1 ER20

### Technical data

<b>Shank TNL</b>	Circular prism
<b>Drive</b>	Overall drive
<b>Fixation TNL</b>	Central tensioning screw
<b>Speed ratio</b>	2:1
<b>Cooling</b>	external
<b>Pressure</b>	30 bar
<b>Mounting</b>	ER20
<b>INDEX TRAUB products</b>	TNK36 • TNL26

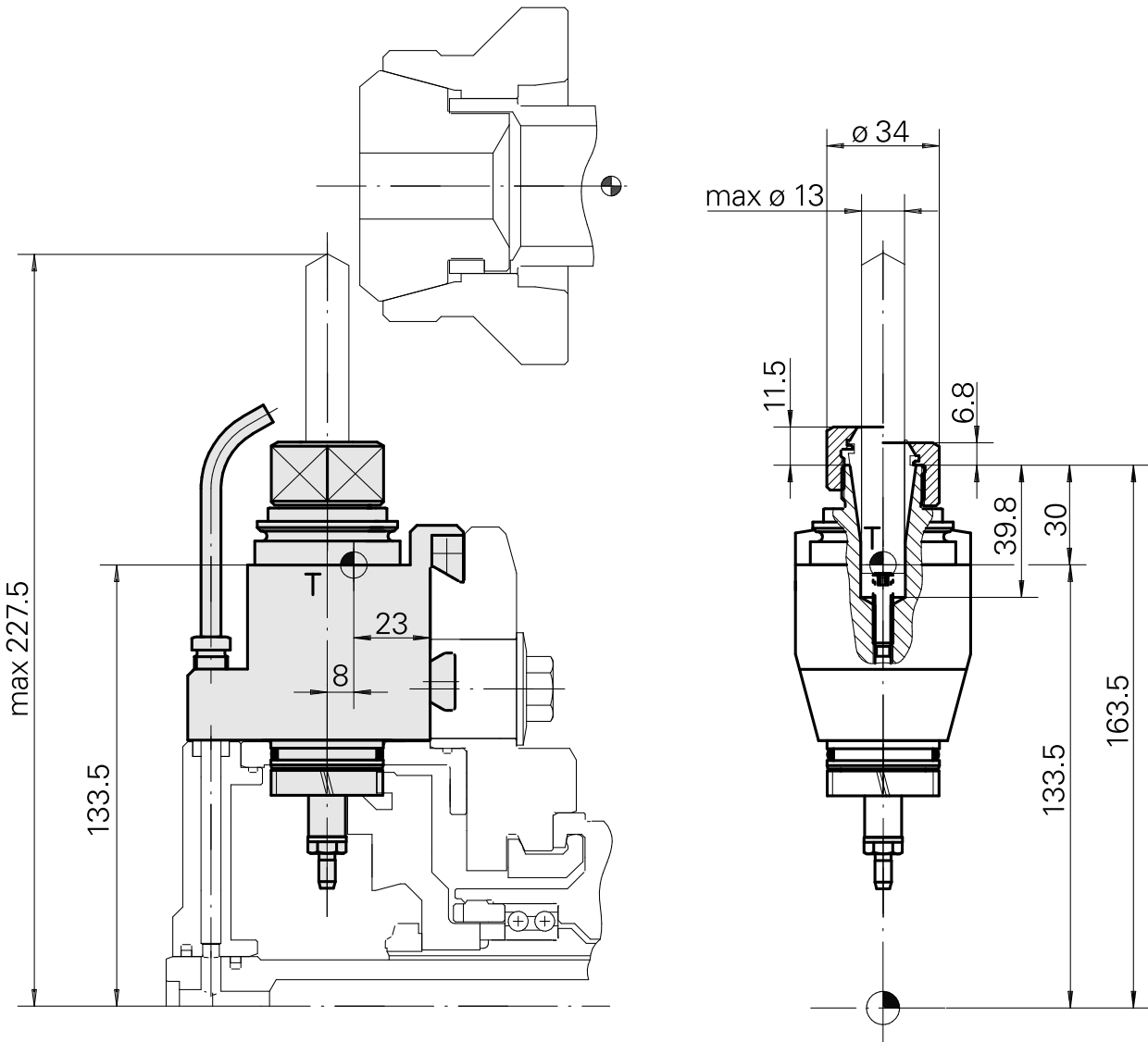
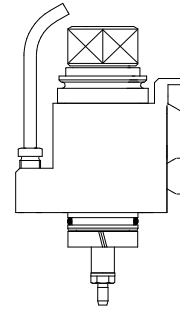

---

## Documents

No downloads available for this product

## Accessories

Required for operation

### [Spanner](#)

Product ID : 10603529

Previous product ID : 490219.0201

TH accessories category Tool	Mounting ER20	Collet type ER 20	Clamping nut type Female thread
Tools for Collet chucks Clamping nut wrench			

### Optional accessories

#### Tool holder accessories

### [Clamping nut](#)

Product ID : 10137535

Previous product ID : 901939.0201

TH accessories category Clamping nut	Mounting ER20	Collet type ER 20	Clamping nut type Female thread
---	------------------	----------------------	------------------------------------

#### Other accessories

### [Clamping collet](#)

Product ID : 10863981

Previous product ID : 901930.2---

---

### [tapping tool collet ET-1-20](#)

Product ID : 10418139

Previous product ID : 3234--

---

11022179  
836909

**INDEX**

---

Collet chuck

Product ID : 10135002

Previous product ID : W999066-

---