

ER-Collet chuck for taps ET 1-25 5mm

Technical data

TH accessories category	ER-Collet chuck for taps
Mounting	ER25
Tool mounting	5mm
Collet type	ET 1-25

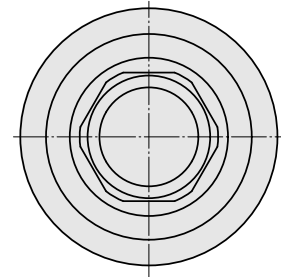
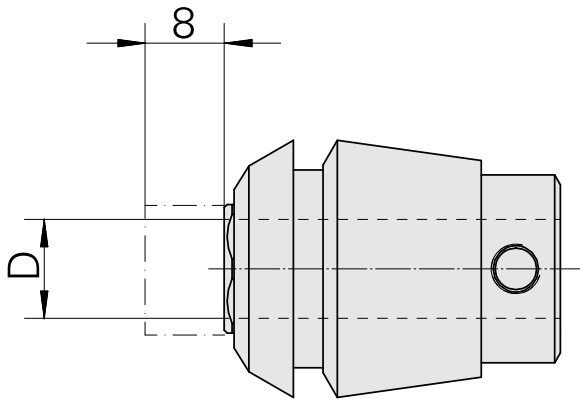

10925692
322461

INDEX

Documents

No downloads available for this product