

WFB 20-12 D10

Technical data

TH accessories category	WFB 20-12
Mounting	D10
Quick change inserts	Weldon mounting

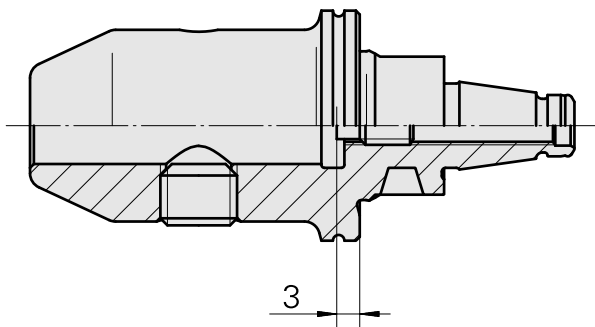
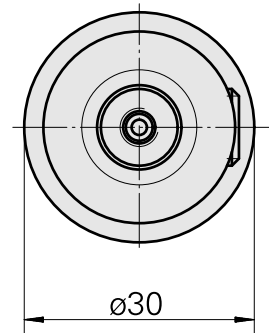
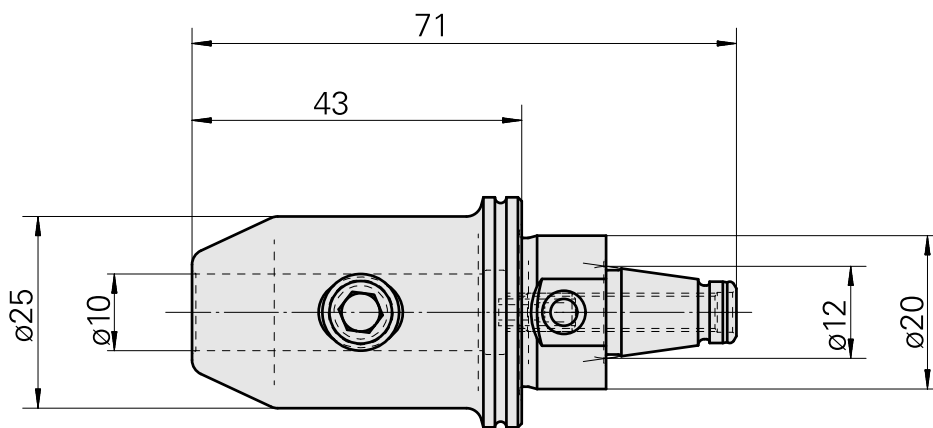
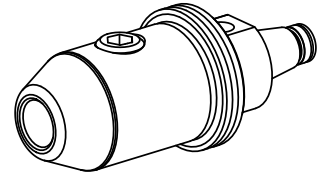

Documents

No downloads available for this product

Accessories

Optional accessories

Other accessories

[Adjusting screw M 5x10](#)

Product ID : 10674886

Previous product ID : 326793

[Clamping screw M10x 8 \(110AWS\)](#)

Product ID : 10398283

Previous product ID : 326791
