

## WFB 32-20 D10

### Technical data

TH accessories category	WFB 32-20
Mounting	D10
Quick change inserts	Weldon mounting

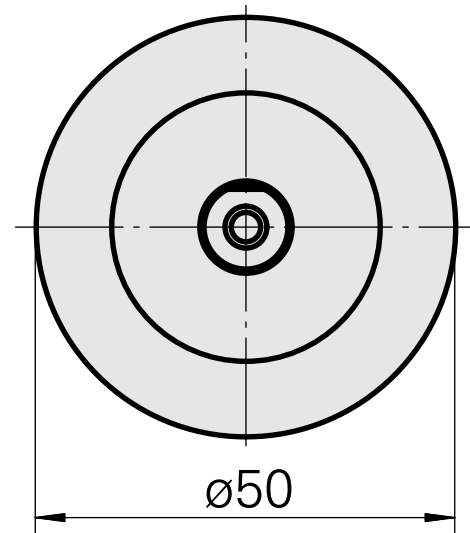
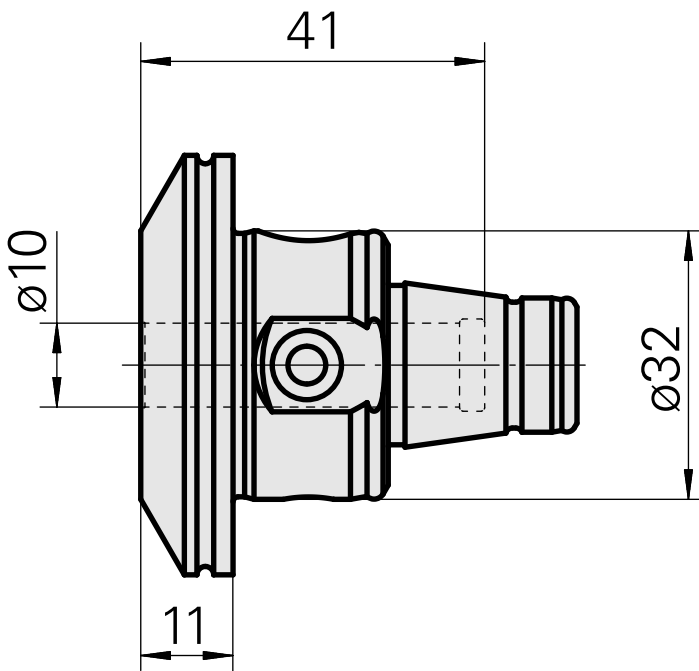

## **Documents**

No downloads available for this product