

Drilling tool holder D32

Technical data

| | |
|----------------------|--|
| Drive | not live |
| Fixation MS | Clamping ring D51 |
| Cooling | internal |
| Pressure | 80 bar |
| Mounting | D32 |
| X [mm] | - |
| Y [mm] | - |
| Z [mm] | - |
| INDEX TRAUB products | MS32C • MS52C • MS32-6.2 • MS40-6 • MS40-8 • MS52-6.3 • MS32-6.3 |

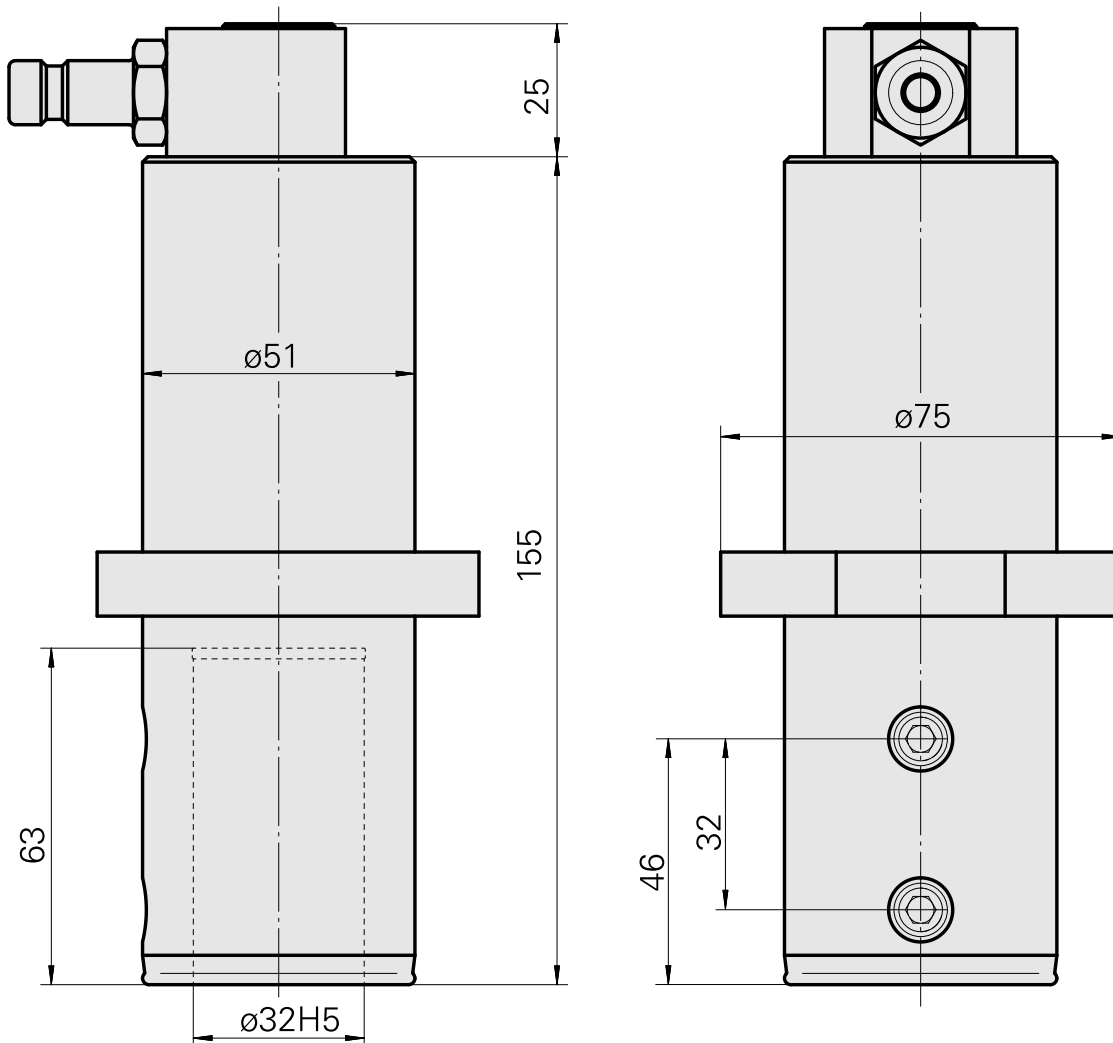
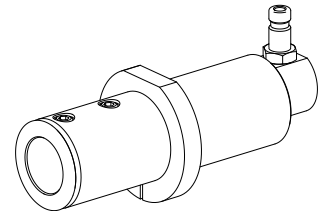

Documents

No downloads available for this product

Accessories

Optional accessories

Other accessories

[Mounting sleeve with collar D32](#)

Product ID : 10505810

Previous product ID : W63221.40--

[QUICK COUPLING SP-006-0-WR513-11-2 Serie LP](#)

Product ID : 10837142

Previous product ID : 474940.0112

[QUICK DISCONNECT FITTING SP-006-1-WR013-11 Serie LP](#)

Product ID : 10186287

Previous product ID : 474946.25
