

WFB 20-12 Hydroexpansible D8

Données techniques

Catégorie d'accessoires PO

WFB 20-12

Attachement

Hydroexpansible D8

Inserts à changement rapide

avec attachem. hydroexpansible

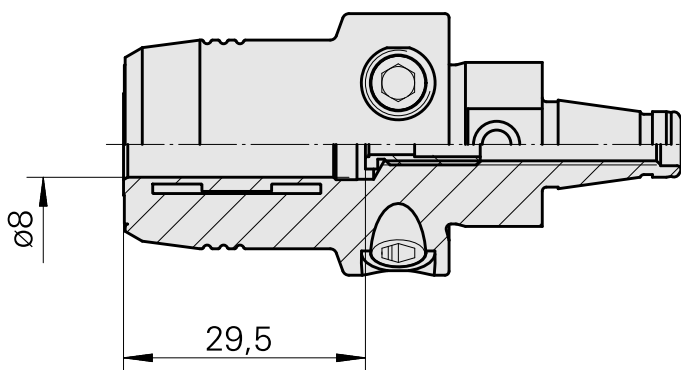
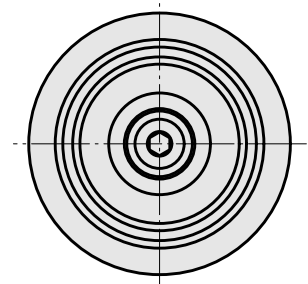
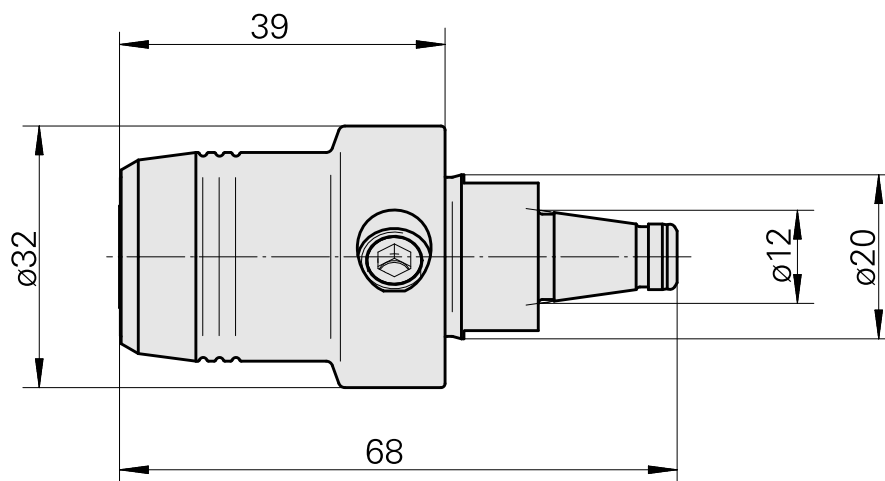
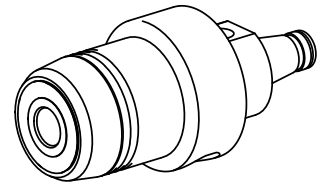

Documents

Remarques concernant les produits

[DE \(pdf\)](#)

[EN \(pdf\)](#)

[FR \(pdf\)](#)