

## WFB 32-20 Montagem ajustamento quente D3

### Características técnicas

PF Categoria de acessórios

WFB 32-20

Recepção

Montagem ajustamento quente D3

Inserções de troca rápida

consumo reduzido

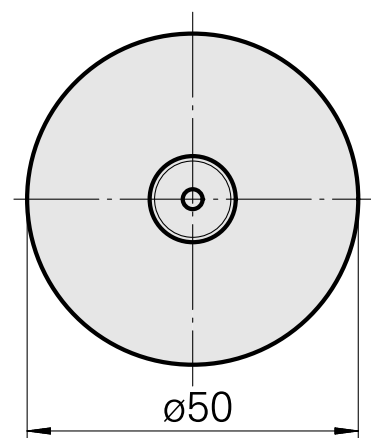
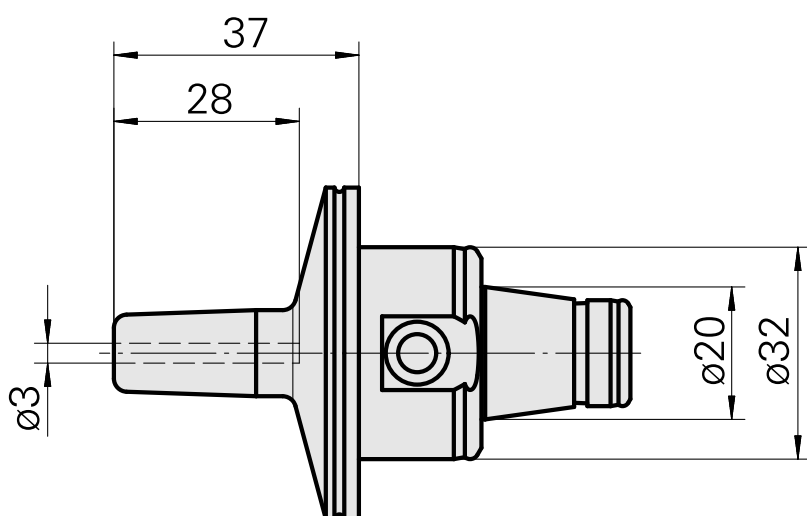
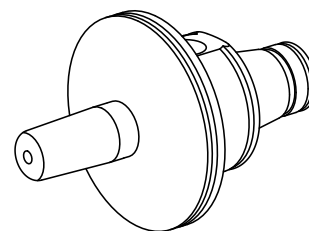

## **Documentos**

Não há downloads disponíveis para este produto