

Porta-brocas HSK 40 A DIN 1835 B/E D6

Características técnicas

Haste HSK	HSK 40
Forma HSK	A
Recepção	DIN 1835 B/E D6
Refrigeração	interno
Pressão (até)	80 bar
X [mm]	45,5
Produtos INDEX TRAUB	G160 • V100 • G200.2 • R200 • TNX65/42 • G220.3 • TNX220.3

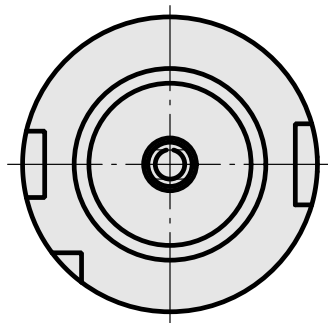
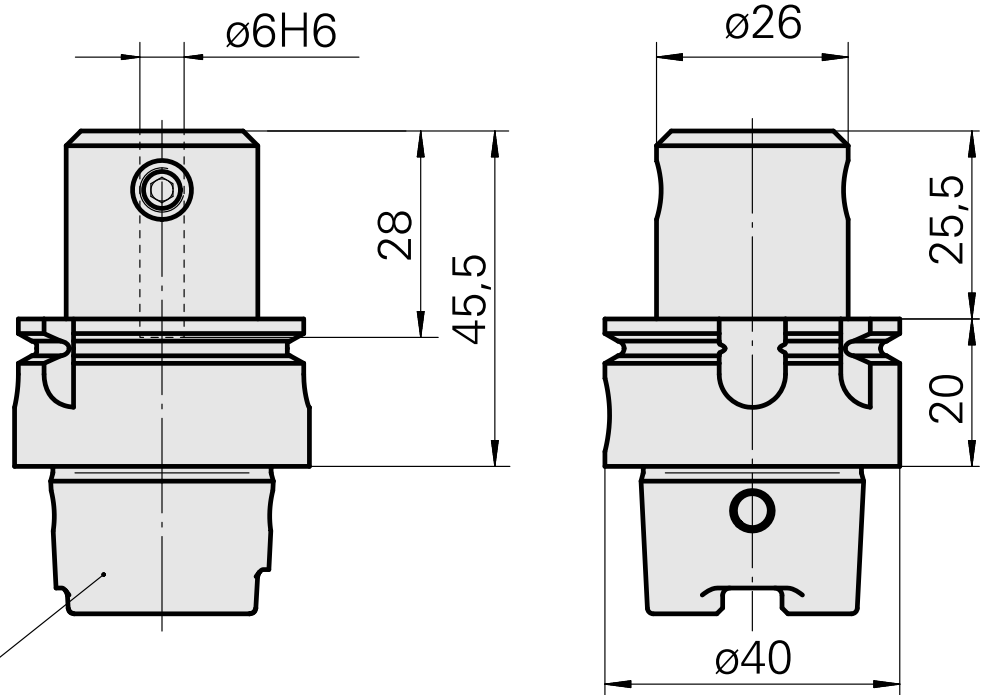

Documentos

Não há downloads disponíveis para este produto

Acessórios

Necessário para operação

[Chave de encaixe](#)

ID do produto : 10532354

ID anterior do produto : WS7400.0010

PF Categoria de
acessórios
Ferramenta para
adaptador KSS

Recepção
HSK 40 A/C

Acessórios opcionais

Tool holder accessories

[Refrigerante Adapter Kit](#)

ID do produto : 10581780

ID anterior do produto : WS7400.0020

PF Categoria de
acessórios
Adattatore
lubrorefrigerante

Recepção
HSK 40 A/C

[Entrada de refrigeração, máx. 120 bar](#)

ID do produto : 12024083

ID anterior do produto :

PF Categoria de
acessórios
Adattatore
lubrorefrigerante

Recepção
HSK 40 A/C