

Milling cutter holder HSK 25 C Milling s

Technical data

Shank HSK	HSK 25
Form HSK	C
Mounting	Milling shaft D8
Cooling	internal
Pressure	40 bar
X [mm]	24 (0.94")
INDEX TRAUB products	MS22-6 • MS22-8 • MS16-6

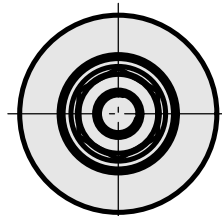
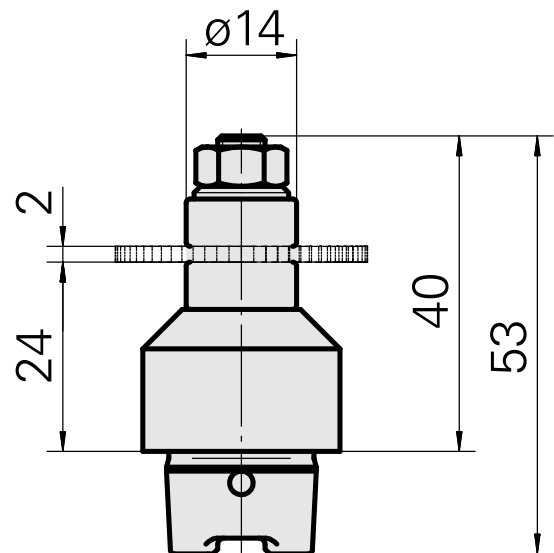
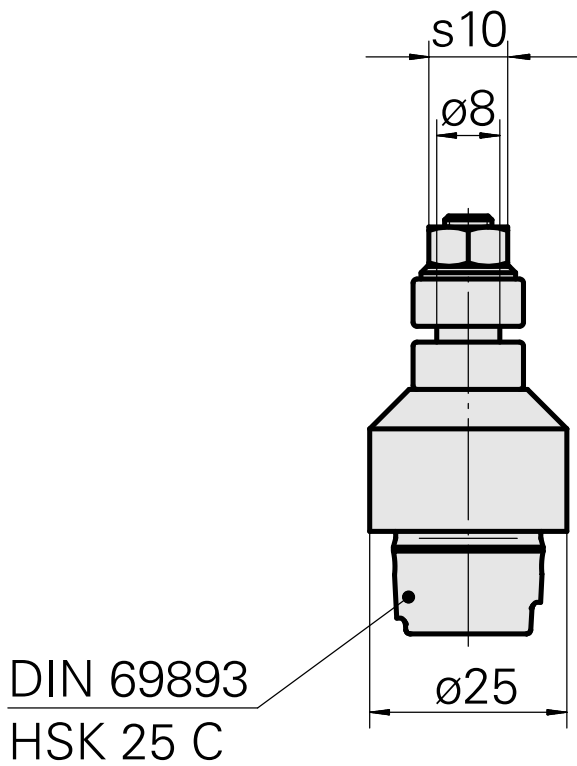
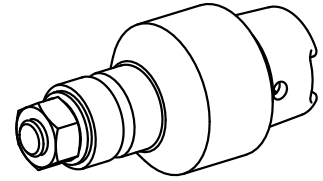

Documents

No downloads available for this product