

ER-Collet chuck for taps ET 1-20 2.8mm

Technical data

TH accessories category	ER-Collet chuck for taps
Mounting	ER20
Tool mounting	2.8mm
Collet type	ET 1-20

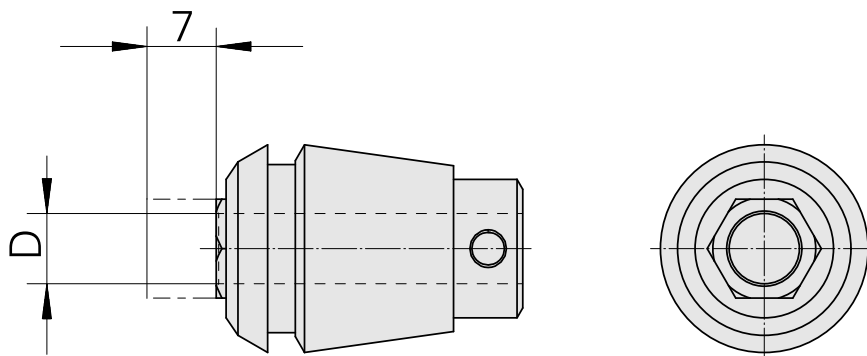

10130701
323441

INDEX

Documents

No downloads available for this product