



INDEX ABC

Tool holder

Technical Information

Note on applicability

Illustrations in this publication may deviate from the product supplied. Errors and omissions due to technical progress expected.

A word on copyright

This document is protected by copyright and was originally compiled in German. The duplication and distribution of this document or parts thereof is prohibited without prior consent of the copyright owner, and any violators will be prosecuted. All rights, including the right to translate, are reserved.

© Copyright by INDEX-Werke GmbH & Co. KG

Technical Information	4
Tool holder selection	4
Warranty	4
Information on wear parts.....	4
Inspection of live tool holders.....	4
Tool holders with cooling lubricant supply.....	5
Cooling lubricant filtering	5
Cleaning live tool holders.....	5
Speed ratio specifications on tool holders	5
Direction of rotation specification	6
Coolant supply	7
Tightening torque.....	7
Replacement seals for tool shank	8
Sealing air port.....	8
Tool holders with fixation	9
High-pressure unit	9
Load limits of live tools	9
Live tool holders	10
Weight distribution on turret head.....	11
Collision.....	11
Tool change on live tool holders.....	11
Notes on how to use the chart when using tool holders	12
 Usage information	 13
Structure of the INDEX ABC	13
Working area of INDEX ABC.....	14
Tool mounting VDI25 with W slots, back-boring station VDI25.....	14
Tool mounting VDI25 with W slots, back-boring station 1".....	16
Performance chart – INDEX ABC with S840D sl.....	18
Live tools, tool carriers 1 and 2.....	18
Performance chart – INDEX ABC with FANUC 31i.....	19
Live tools, tool carrier 1	19
Live tools, tool carrier 2	20

Tool holder selection



For more information, please visit our iXshop at ixshop.index-traub.com

We will be happy to send you an individual offer. Just call us at +49 711 3191-9854 or send us an email to werkzeughalter@index-werke.de.

Warranty



When using tool holders that are not adjusted, tested and marked as such by INDEX TRAUB, the warranty for the tool drive is void.

Information on wear parts

Tool holders are wear parts requiring correct handling. In order to ensure a long service life, compressed air or coolant must not enter the gap seals of the holders.

Inspection of live tool holders



Tool holders must be inspected at regular intervals (at least twice a year) for smooth running and play.



The drive pinion and drive clutch of the live tool holders must be subjected to a visual inspection for damage or wear.

If one of the above-mentioned defects is detected during the inspection of the tool holders, they must be returned immediately for preventive maintenance or repair to the following address:

INDEX-Werke GmbH & Co. KG
Hauffstraße 4
D-73262 Reichenbach
Fon +49 711 3191-554
werkzeughalter@index-werke.de

Tool holders with cooling lubricant supply



Tool holders marked with this symbol must be operated with cooling lubricant (no dry running permitted).



Tool holders marked with this symbol can be converted from external cooling lubricant supply to internal cooling lubricant supply. Observe dry running capability of IC attachment!

Cooling lubricant filtering

When using live tool holders with internal cooling lubricant supply, it is necessary to use a cooling lubricant filter system with a retained particle size $\leq 50 \mu\text{m}$.

Cleaning live tool holders

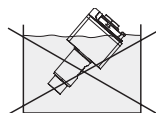

Live tool holders must never be immersed in cleaning fluid since mixing the cleaning fluid with the bearing grease will reduce the service life of the tool holders.

Speed ratio specifications on tool holders

The value to be programmed is specified in the documentation and on the live tool holders (= the input in the NC program).

$$n_{\text{prog}} = n_{\text{Tool}} \times i$$

n_{Tool} = speed at the cutting tool edge

n_{PROG} = speed to be programmed

i = speed ratio in the tool holder

This means the speed increase or speed reduction is not specified as a fraction but as **a number**.

This gives speed **increase** ratios as numbers **less than 1**.

Example: $i = 0.333$ (corresponds to $i = 1:3$)
 $i = 0.676$ (corresponds to $i = 1:1.48$)

Speed reduction ratios are numbers greater than 1.

Example: $i = 2$ (corresponds to $i = 2:1$)
 $i = 1.333$ (corresponds to $i = 4:3$)



Direction of rotation specification

Definition of the viewing direction.

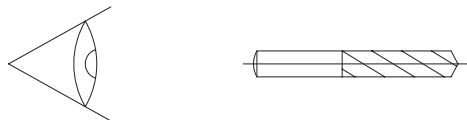
Viewing direction for determining the direction of rotation is always from behind (that is, from the drive direction) toward the shaft.



On the machine side, the direction of rotation has been set by parameters such that M03 always denotes clockwise rotation and M04 counter-clockwise rotation at the interface of the drive pinion of the tool holder.

The direction of rotation given on the holder therefore refers to a "change in direction within the holder". M03 and M04 are machine functions to be programmed. The  and  arrows indicate the direction of rotation of the cutting edges.

This means:



No reversal of direction of rotation

When the holder drive shaft has the **same** direction of rotation as the tool cutting edge, the clockwise direction of run must be specified by M03 (clockwise rotation). Accordingly, counter-clockwise rotation must be specified by M04.



Reversal of direction of rotation

When the holder drive shaft has the **opposite** direction of rotation as the tool cutting edge, the clockwise direction of rotation must be specified by M04. Accordingly, counter-clockwise rotation must be specified by M03.

Example

No reversal of direction of rotation

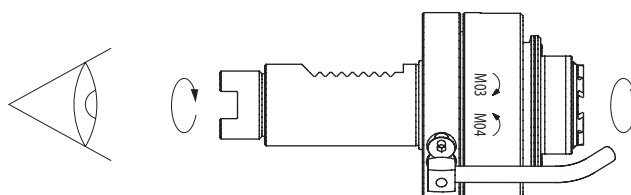

Coolant supply

For tools with W-serration and double clamping serration, the 2nd hole for coolant supply through the end plug and the seal must be closed.

The gaskets on the tool shank and the coolant bushing must be regularly checked for damages.

Tightening torque

The tightening torques of the clamping pieces to the tool holder mounting depends on the shank diameter of the tool holder.

Shank size	Tightening torque
Ø 20 mm	8 Nm
Ø 25mm	20 Nm
Ø 30mm	25 Nm
Ø 40mm	40 Nm

Replacement seals for tool shank

The gaskets on the tool shank and the cooling lubricant bushing must be regularly checked for damages.

O-ring	O-ring color	Material number	Installation location
ø18.77 x 1.78	Green	10763730	Shank ø20
ø23.52 x 1.78	Green	10823023	Shank ø25
ø9.75 x 1.78	Green	10046965	Cooling lubricant adapter
ø28.3 x 1.78	Green	10777976	Shank ø30
ø37.77 x 2.62	Green	10066870	Shank ø40
ø38.60 x 2.90	Red	10598581	Shank ø40
ø12.42 x 1.78	Green	10824672	Cooling lubricant adapter

The color of the reordered O-ring must always be the same as the one already used on the tool shank.

Sealing air port

It must be ensured on all machines with sealing air ports that the sealing air ports in the tool carrier and in the tool holders are sealed/closed with M5x6 mm set screws.

Tool holders with fixation



Except for very few cases, all tool holders have been pre-adjusted with high precision and sealed with the INDEX V bar / TRAUB adjusting bar / W-serration.

This setting must not be changed.

The INDEX V bar / TRAUB adjusting bar / W-serration ensures positional accuracy of the tool when re-inserted.

The tool holders are fixed around the shank axis by pins (DIN 69880).

DIN holders can be used.

Double serration of the tool holders allows several uses.

High-pressure unit



The cooling lubricant up to 80 bar (e.g., for deep-hole drilling) is supplied through the standard cooling lubricant line.

Load limits of live tools

The drive power and torques are indicated in the performance charts. These values represent the upper limit of the calculated theoretical performance values (average values). In case of interrupted cuts, e.g., for milling, the load peaks occurring when the cutting edge enters the material may be much higher than the theoretical torque according to the performance chart.



The cutter should be selected so that a cutting edge is constantly being used for cutting during the machining process.

Live tool holders

Only the tool located in the working position is live.

The live tool holders are inserted into the mounting bores in the tool carriers just like non-live tool holders.

Each turret station can accept one live tool.

The motor drives the tool that is exclusively in working position. In addition, the index drive is actuated by switching using the same motor.



The sealing washer (1) must be removed first.

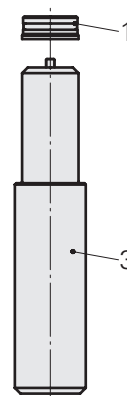
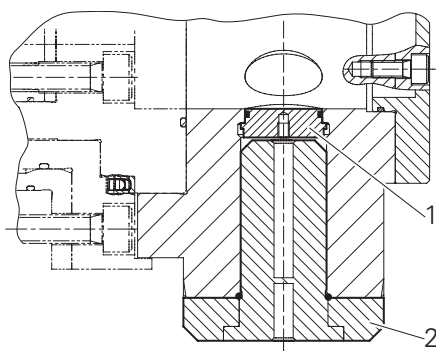

- | | | |
|---|----------------|----------|
| 1 | Blanking plug | 10730214 |
| 2 | Blanking plugs | 10396777 |
| 3 | Mounting pin | 10010523 |



Before using the machine, make sure that all mounting bores without a tool have been closed with a sealing washer and that the gasket on all tool holders is not damaged.



Any mounting bores not used must be closed with blanking plugs during machining processes.

Weight distribution on turret head



Tool holders may have considerably different weights depending on their function and equipment. Therefore, be sure to balance the tool holders evenly around the turret head when tooling.

Collision



After a collision has occurred, check whether the tool carrier has been displaced. If this is the case, the tool carrier must be realigned to ensure that the drive and tool holder gears accurately engage with each other.

Tool change on live tool holders

To avoid damaging or changing the adjustment of the drive train in the turret, tools must **not** be changed on the live tool holders inserted in the turret.

Tools in live tool holders must be changed outside the machine.

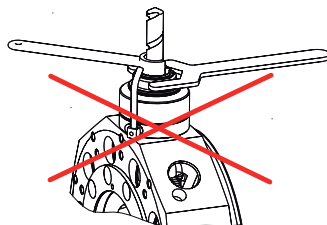

Notes on how to use the chart when using tool holders

The diagram relates to the output speed **n** of the tool unit. The tool speed can be read directly from the diagram only if the internal speed ratio **i** in the tool holder is 1:1.

For tool holders with an internal speed ratio $i \neq 1$, the output speed **n** of the tool unit to be programmed must be calculated from the required tool speed and the speed ratio **i**. Afterwards, the actual powers or torques can be read off or determined.

Example (at 100% duty cycle):

live tool unit, tool speed $n_{\text{tool}} = 1000 \text{ rpm}$	
Internal speed ratio <i>i</i> of the tool holder	$i = 4$
Programmed speed n_{prog} for the drive of the unit	$n_{\text{prog}} = n_{\text{tool}} \times i = 1000 \text{ rpm} \times 4 = 4000 \text{ rpm}$
Torque M_{tool} at the output of the tool holder	Read-out M_d at speed $n_{\text{prog}} = 4000 \text{ rpm} = 1.6 \text{ Nm}$ $M_d = M_{\text{tool}} : i$ Formula changed: $M_{\text{Tool}} = M_d \times i = 1.6 \text{ Nm} \times 4 = 6.4 \text{ Nm}$
Power <i>P</i> at the output of the tool holder ≈ Power <i>P</i> at the output of the setup	Read-out at 4000 rpm → $P = 0.67 \text{ kW}$ calculated: $P = 2 \times \pi \times n_{\text{prog}} \times M_d$ $P = \frac{2 \times \pi \times 4000 \times 1.6 \text{ Nm}}{60 \times 1000} = 0.67 \text{ kW}$

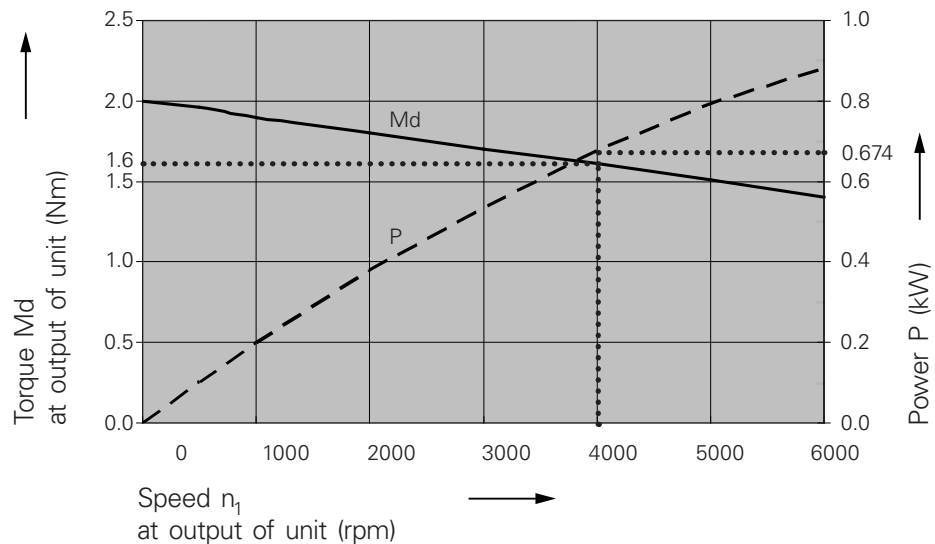

The speed ratio and the technical data of each tool holder are indicated on the next pages.

Structure of the INDEX ABC

Tool mounting VDI25

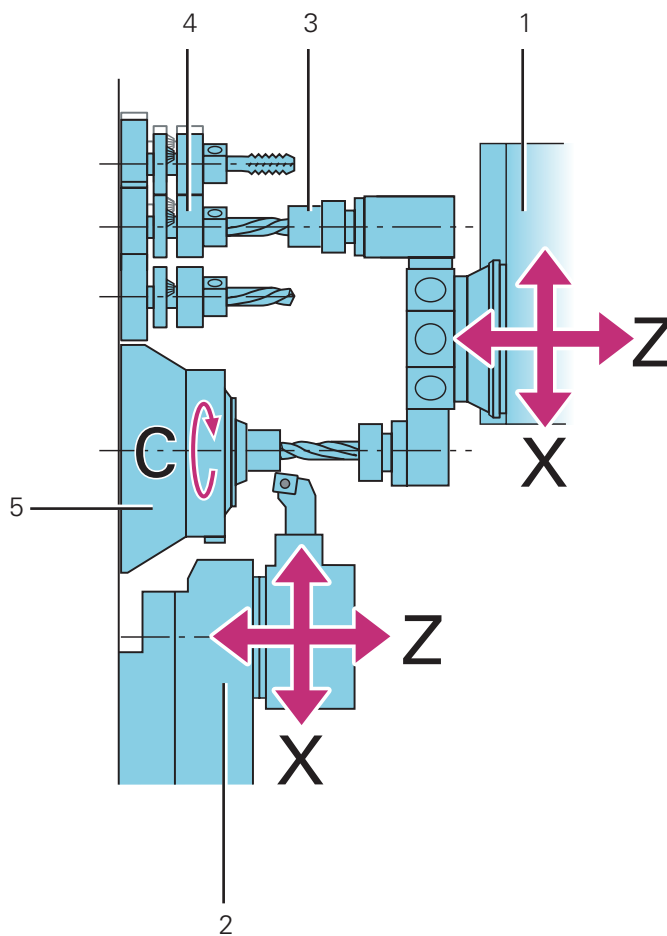

- 1 Tool carrier 1 XZ, shank VDI25
- 2 Tool carrier 2 XZ, prism mounting
- 3 Synchronized spindle
- 4 Back-boring station, shank VDI25 / 1"
- 5 Main spindle

Working area of INDEX ABC

Tool mounting VDI25 with W slots, back-boring station VDI25

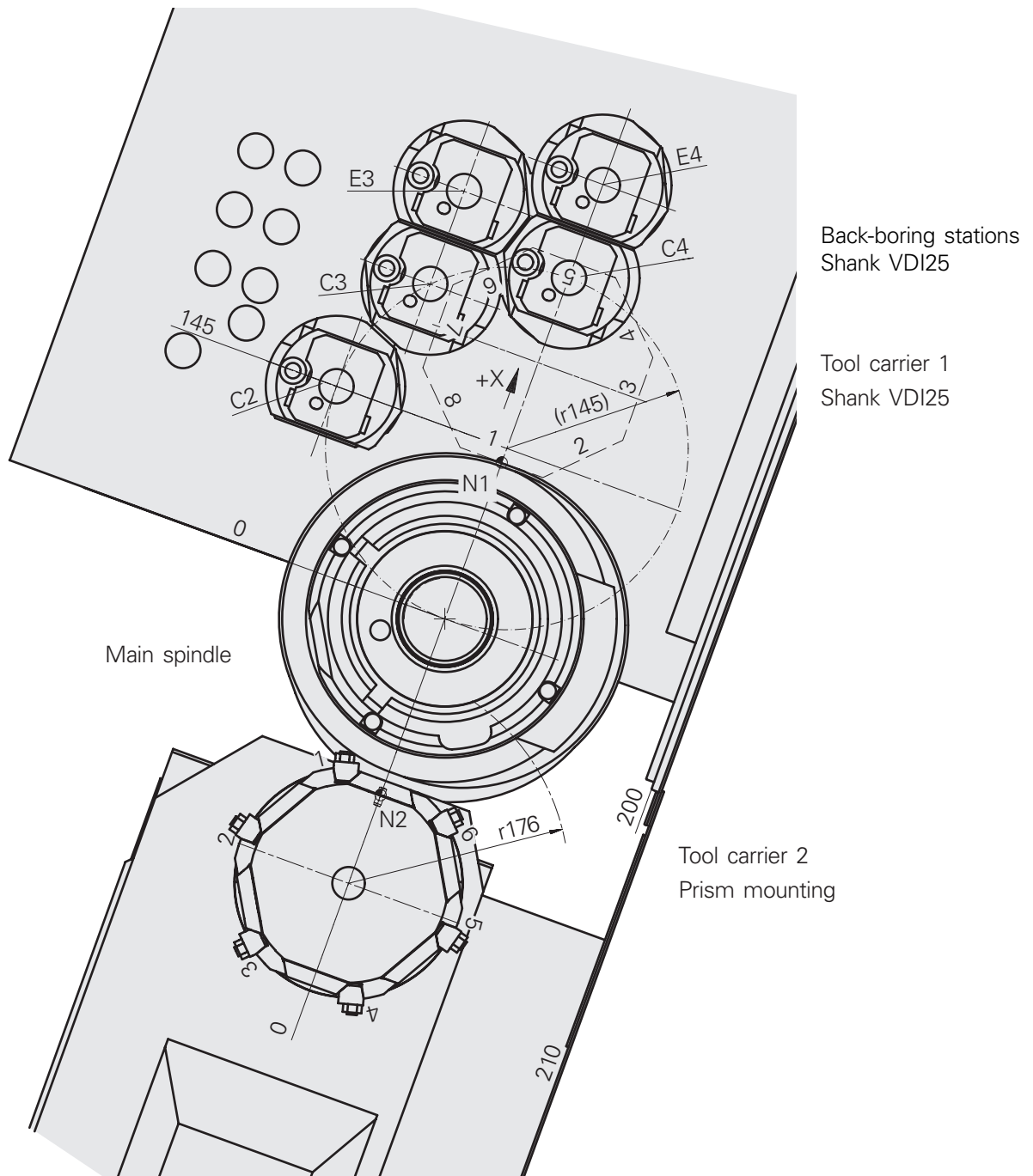

Working area of INDEX ABC

Tool mounting VDI25 with W slots, back-boring station 1"

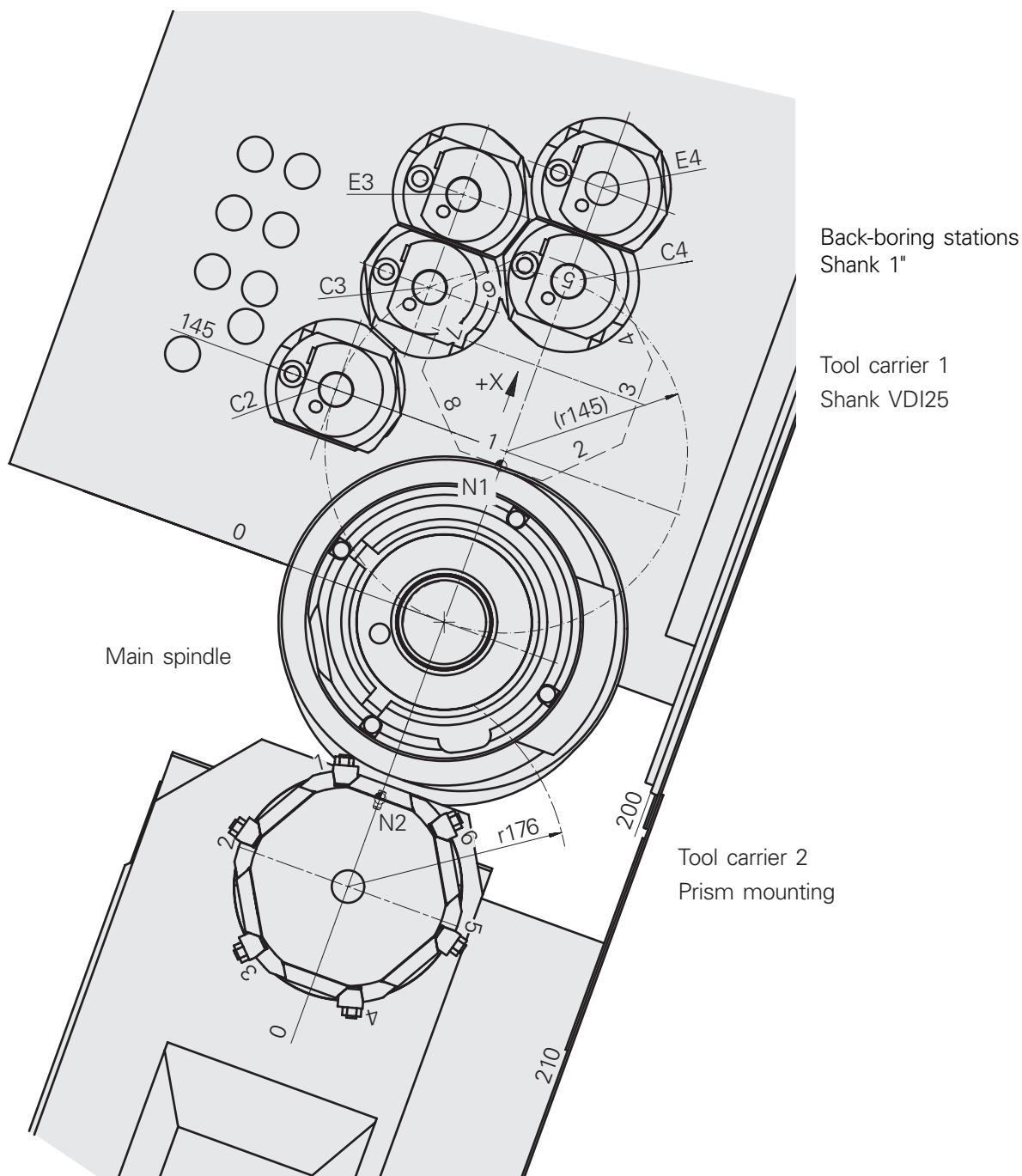

Performance chart – INDEX ABC with S840D sl

Live tools, tool carriers 1 and 2

Speed range 0-6000 rpm

i For information on how to use the diagram, see Chapter "Technical Information".

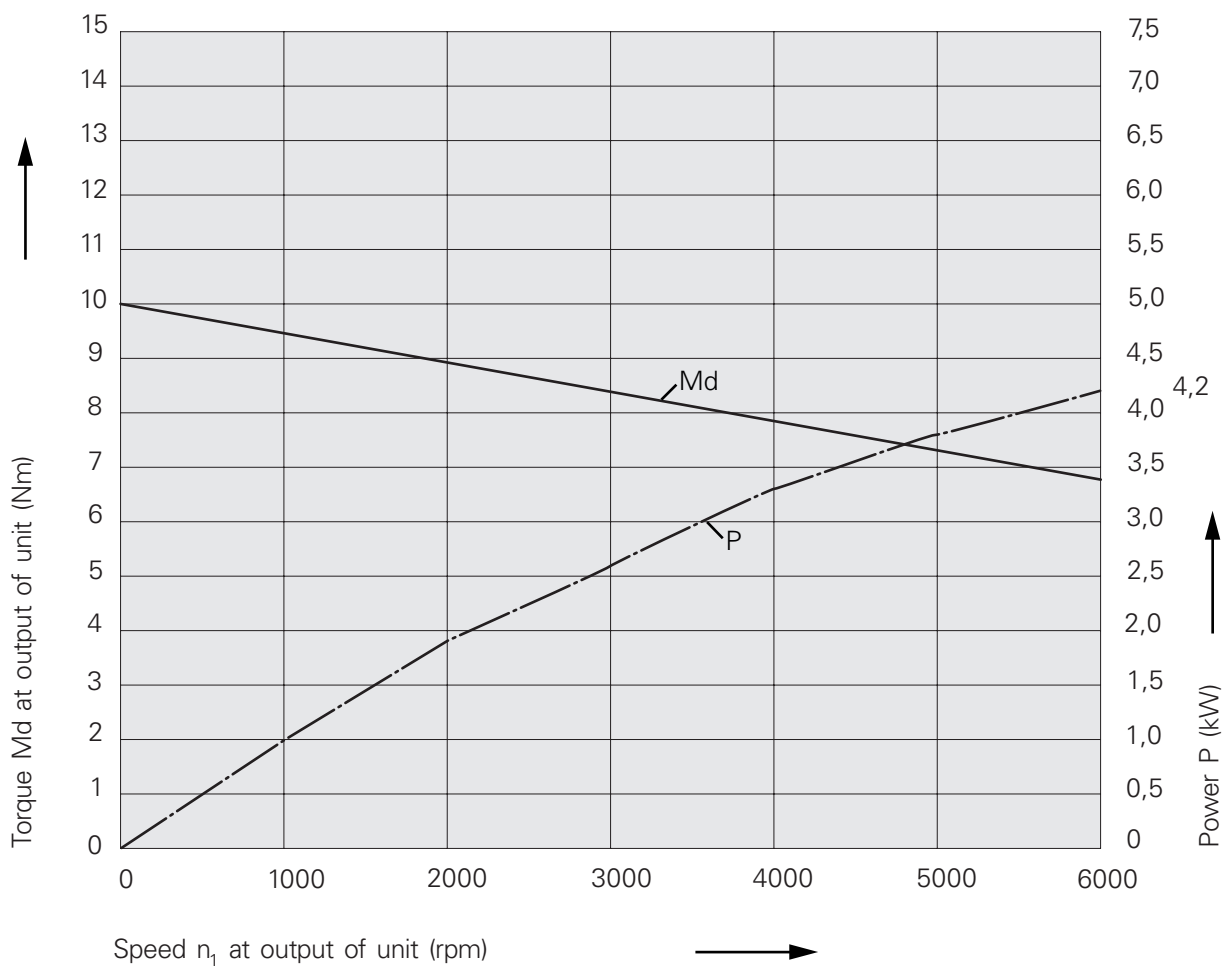

Performance chart – INDEX ABC with FANUC 31i

Live tools, tool carrier 1

Speed range 0-8000 rpm

i For information on how to use the diagram, see Chapter "Technical Information".

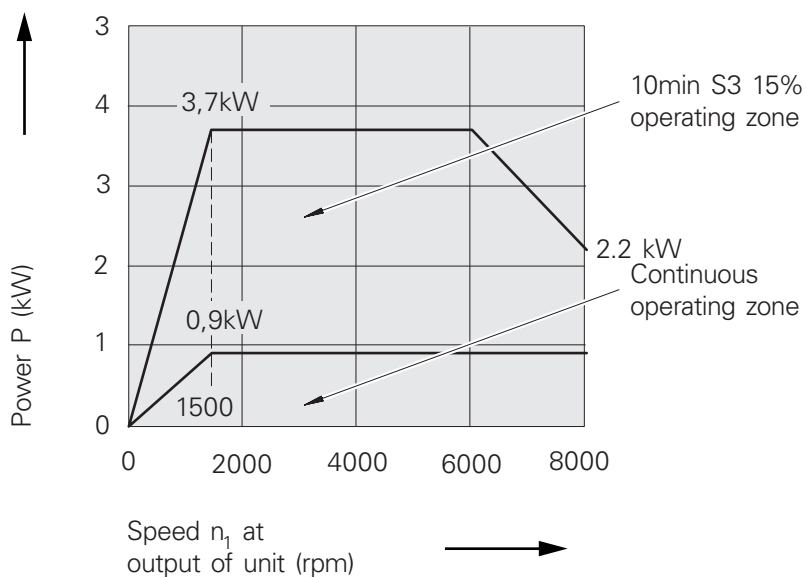
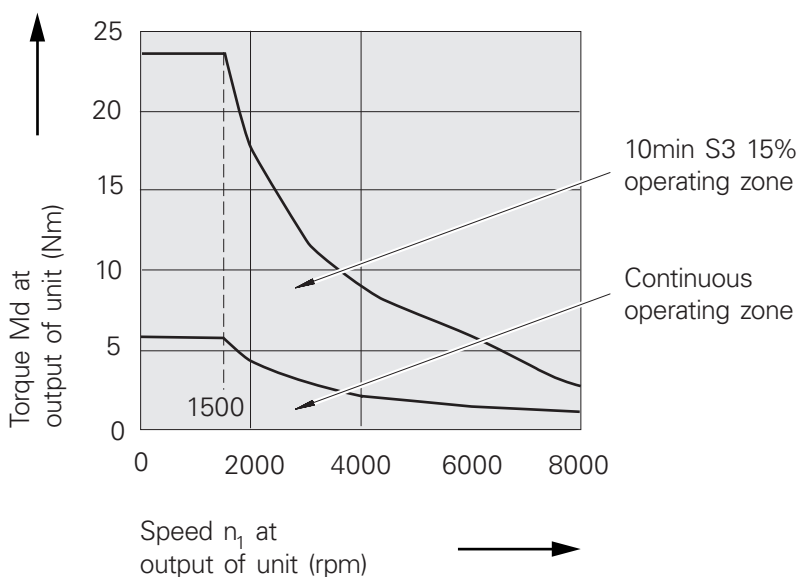

Performance chart – INDEX ABC with FANUC 31i

Live tools, tool carrier 2

Speed range 0-6000 rpm

i For information on how to use the diagram, see Chapter "Technical Information".

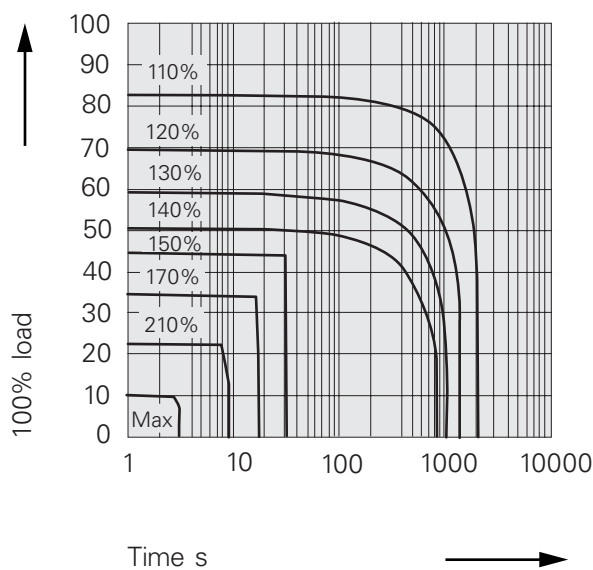
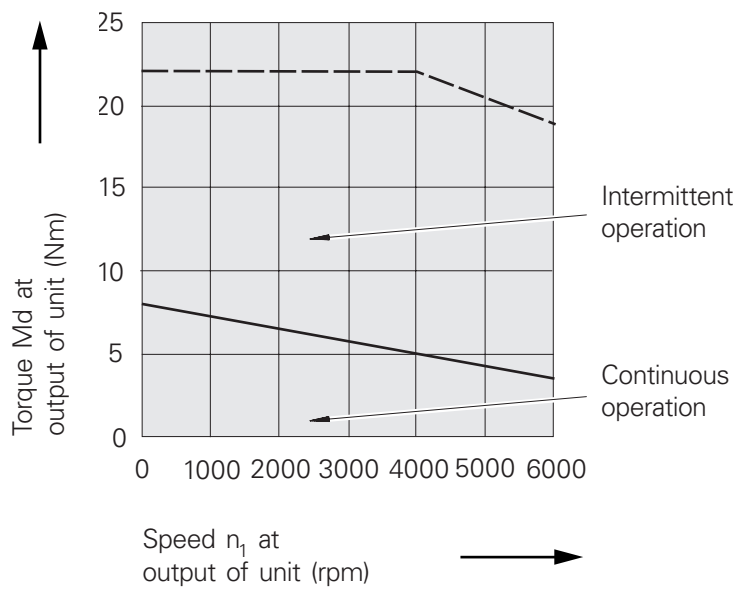



**INDEX-Werke GmbH & Co. KG
Hahn & Tessky**

Plochinger Straße 92
D-73730 Esslingen

Fon +49 711 3191-0
Fax +49 711 3191-587

info@index-werke.de
www.index-werke.de