

Nastro da sega, larghezza lama sega circolare 1,6 mm

Caratteristiche tecniche

Categoria acces. portautensile	Lama sega circolare d63
Attacco per utensile	16 mm

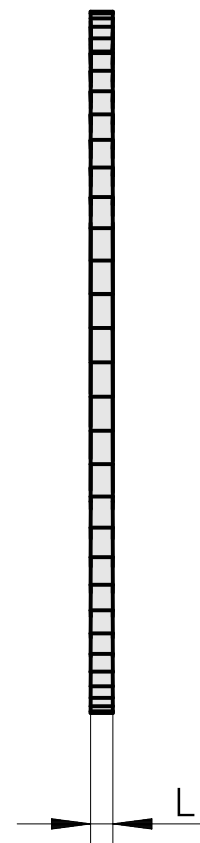
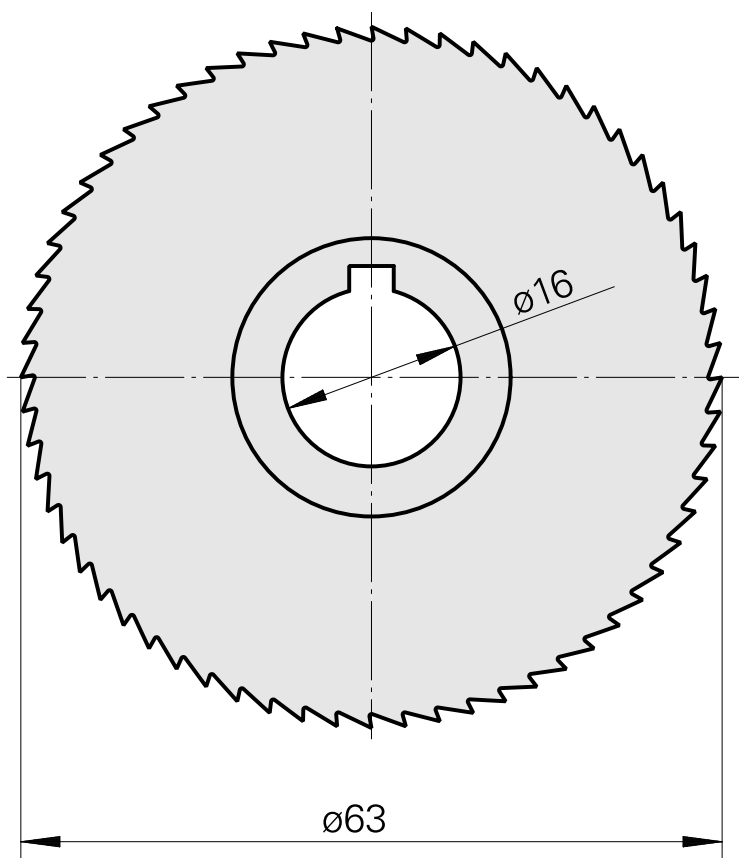
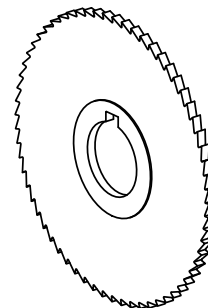

Documenti

Non sono disponibili download per questo prodotto