

WFB 32-20 for CC.. 09T3.., right, without gripper groove

Technical data

TH accessories category

WFB 32-20

Mounting

for CC.. 09T3..

Quick change inserts

Turning tool holder

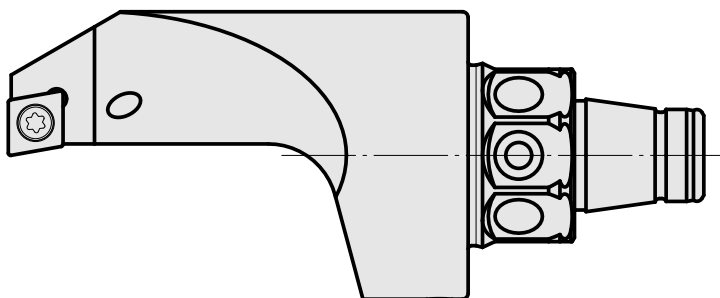
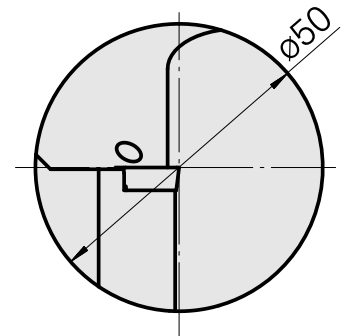
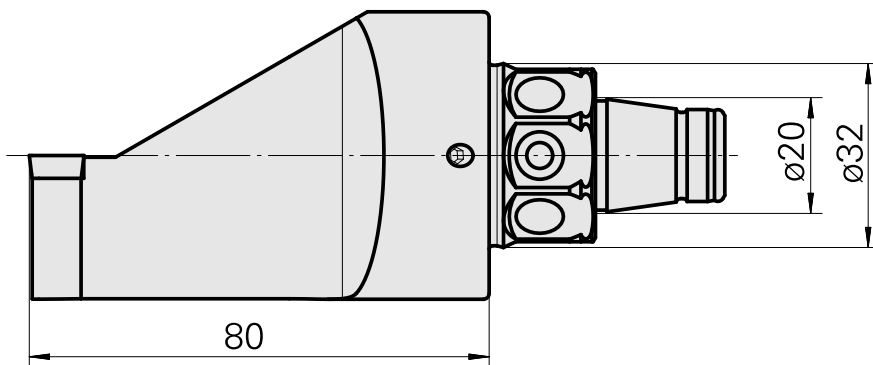
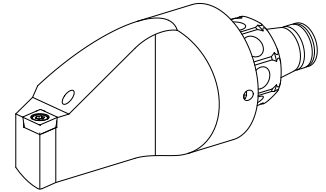

10119611
W9990883

INDEX

Documents

No downloads available for this product