

## Adaptor ER25

### Technical data

There are currently no additional technical features stored for this product

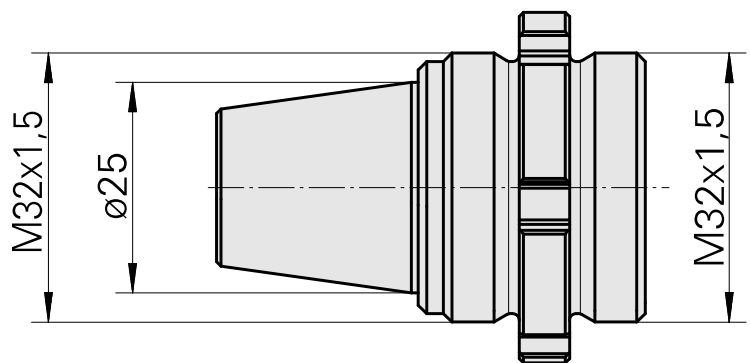
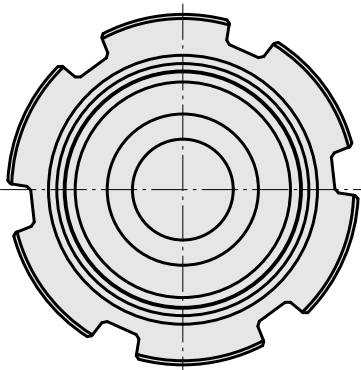

## **Documents**

No downloads available for this product