

## Drilling tool holder Hydraulic expansion

### Technical data

Drive	not live
Fixation MS	Clamping ring D36
Cooling	internal
Pressure	80 bar
Mounting	Hydraulic expansion chuck D8
X [mm]	-
Y [mm]	-
Z [mm]	-
INDEX TRAUB products	MS32-6.2 • MS40-6 • MS40-8 • MS32C • MS32-6.3

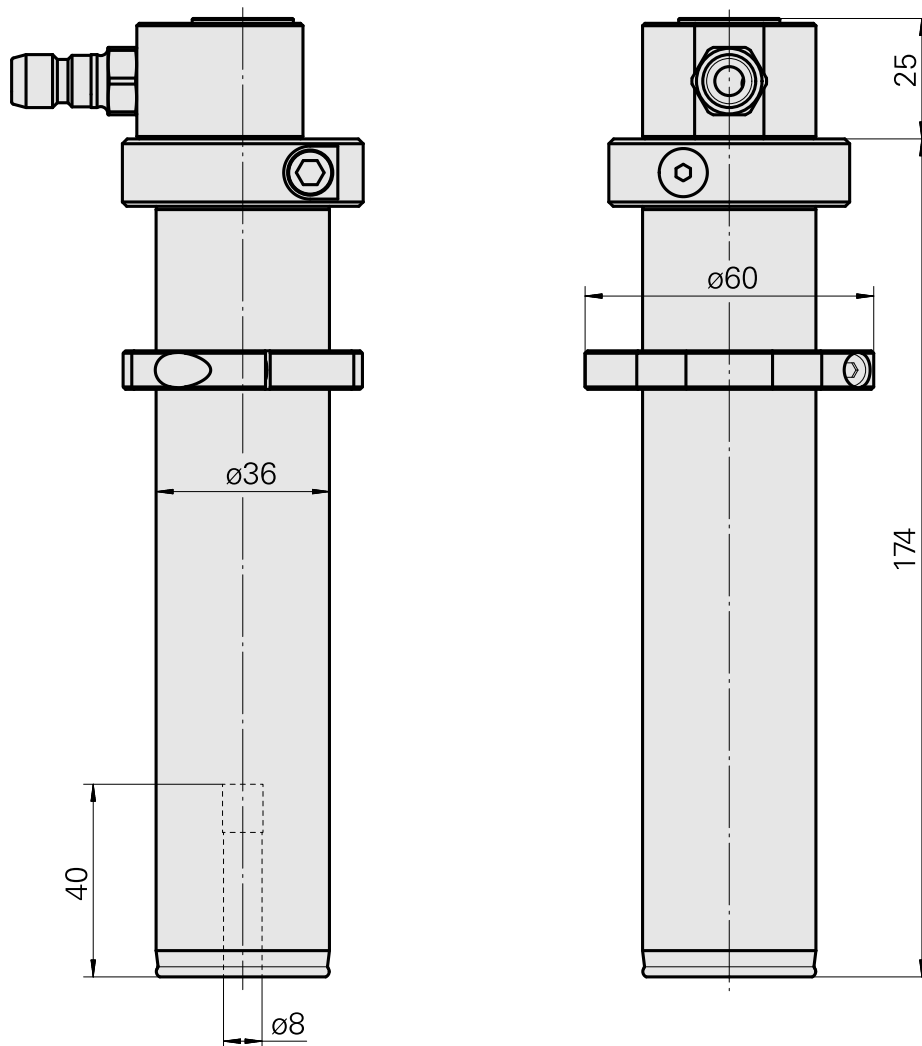
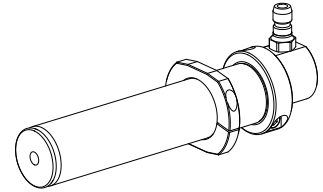

## Documents

### Product notes

[DE \(pdf\)](#)

[EN \(pdf\)](#)

[FR \(pdf\)](#)

## Accessories

Optional accessories

### Other accessories

[QUICK COUPLING SP-006-0-WR513-11-2 Serie LP](#)

Product ID : 10837142

Previous product ID : 474940.0112

---