

WFB 20-12 D16

Technical data

TH accessories category	WFB 20-12
Mounting	D16
Quick change inserts	Boring tool holder

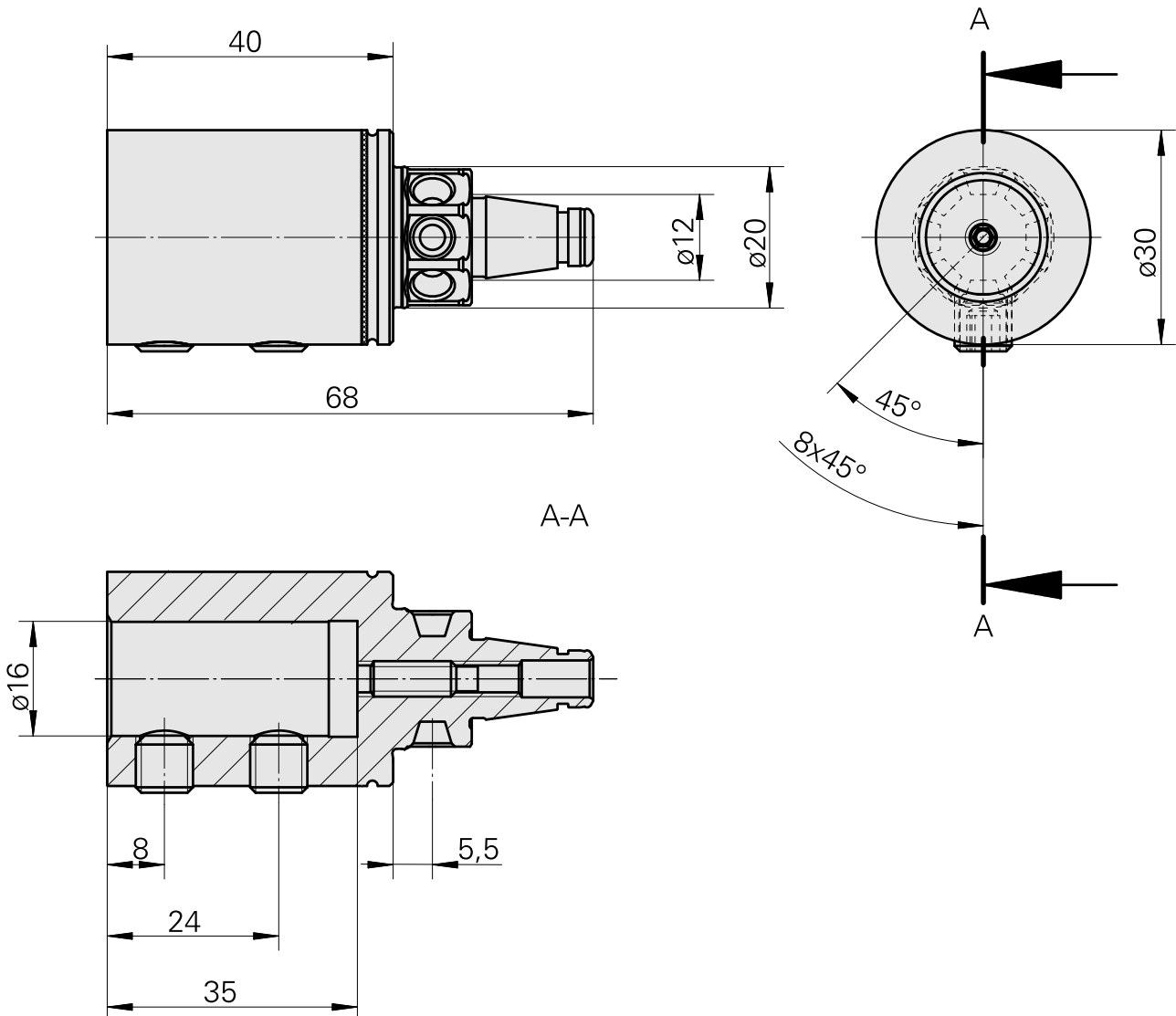
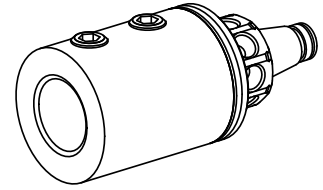

Documents

No downloads available for this product

Accessories

Optional accessories

Other accessories

[Mounting sleeve with collar D16](#)

Product ID : 10914323

Previous product ID : W67511.04--

[Adjusting screw M 5x15](#)

Product ID : 10491071

Previous product ID : 326794

[SET SCREW 8X8-913](#)

Product ID : 10921433

Previous product ID : 410156.0808
