

Probe holder VDI 40 Renishaw D11,2

Technical data

Shank VDI	VDI 40
Drive	not live
Fixation VDI	none
Mounting	Renishaw D11,2
reversible 180°	no
X [mm]	24 (0.94")
Y [mm]	-
Z [mm]	-

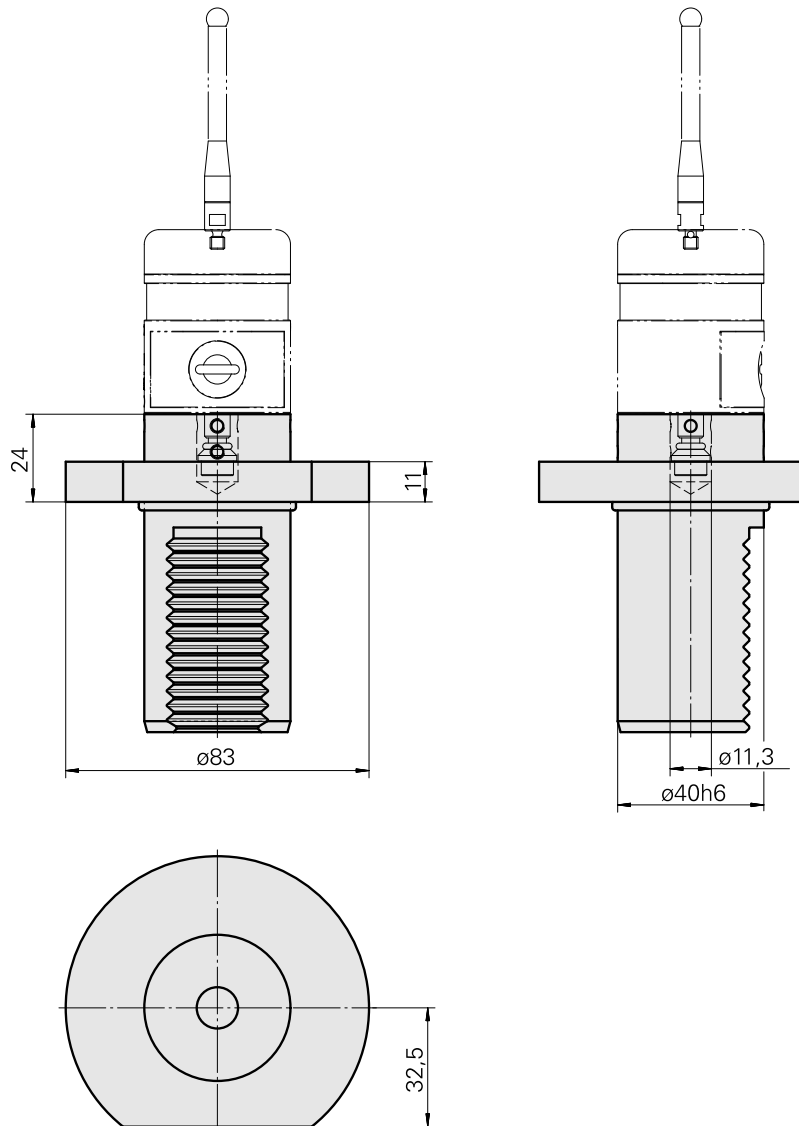

Documents

No downloads available for this product

Accessories

Required for operation

Not defined

Product ID : 12133465

Previous product ID :

Push-button insert

Product ID : 12133466

Previous product ID :

Probe

Product ID : 10338967

Previous product ID : 487542.1441

Optional accessories

Other accessories

Case A-2033-7001

Product ID : 10259626

Previous product ID : 487542.0911
