

## Drilling tool holder Shank 40 D10 (0.39)

### Technical data

Shank TNL	Shank 40
Drive	not live
Cooling	internal
Pressure	120 bar
Mounting	D10
INDEX TRAUB products	TNK36 • TNL26

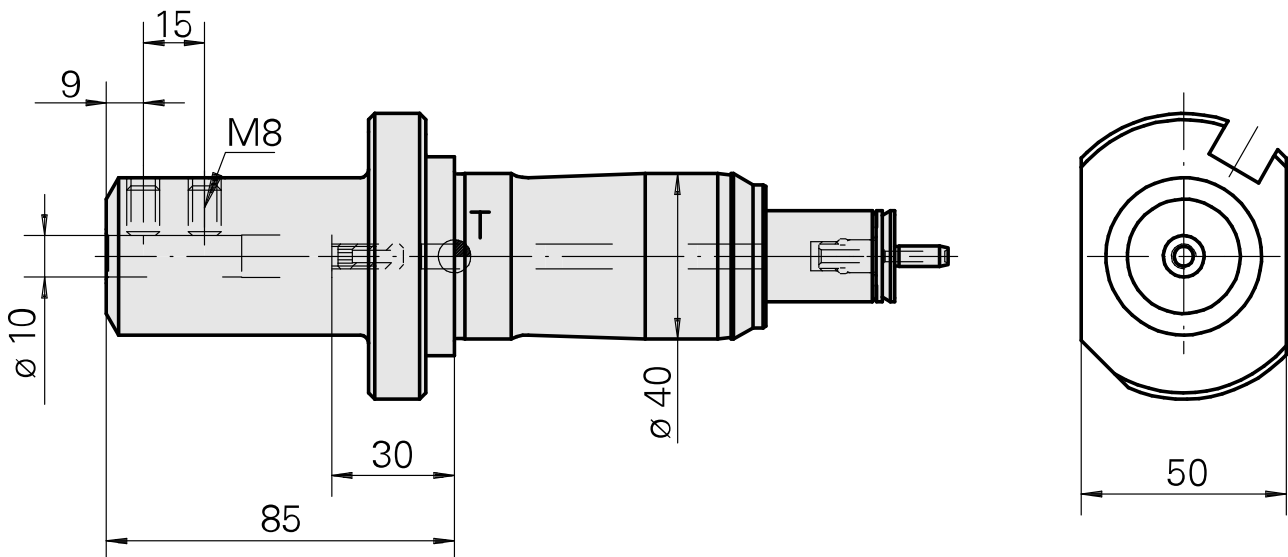
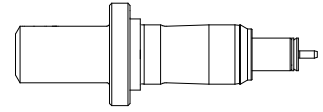

10835923  
835255

**INDEX**

---

## **Documents**

No downloads available for this product