

ER-Collet chuck for taps ET 1-20 5mm

Technical data

TH accessories category	ER-Collet chuck for taps
Mounting	ER20
Tool mounting	5mm
Collet type	ET 1-20

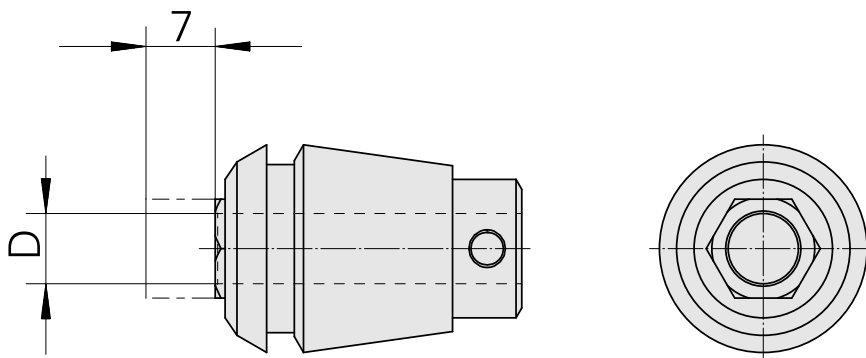

10767883
323446

INDEX

Documents

No downloads available for this product