

Grooving tool holder MS32/MS40 Forming t

Technical data

Slide system MS	MS32/MS40
Drive	not live
Fixation MS	Dovetail
Cooling	external
Pressure	40 bar
Direction	right-handed run
Mounting	Forming tool AWN 20
X [mm]	43 (1.69")
Y [mm]	–
Z [mm]	29 (1.14)
INDEX TRAUB products	MS32C • MS32-6.2 • MS40-6 • MS32-6.3

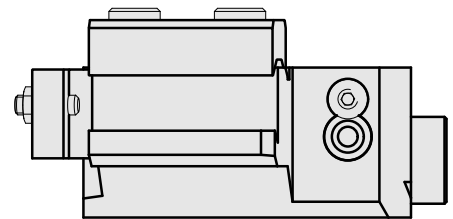
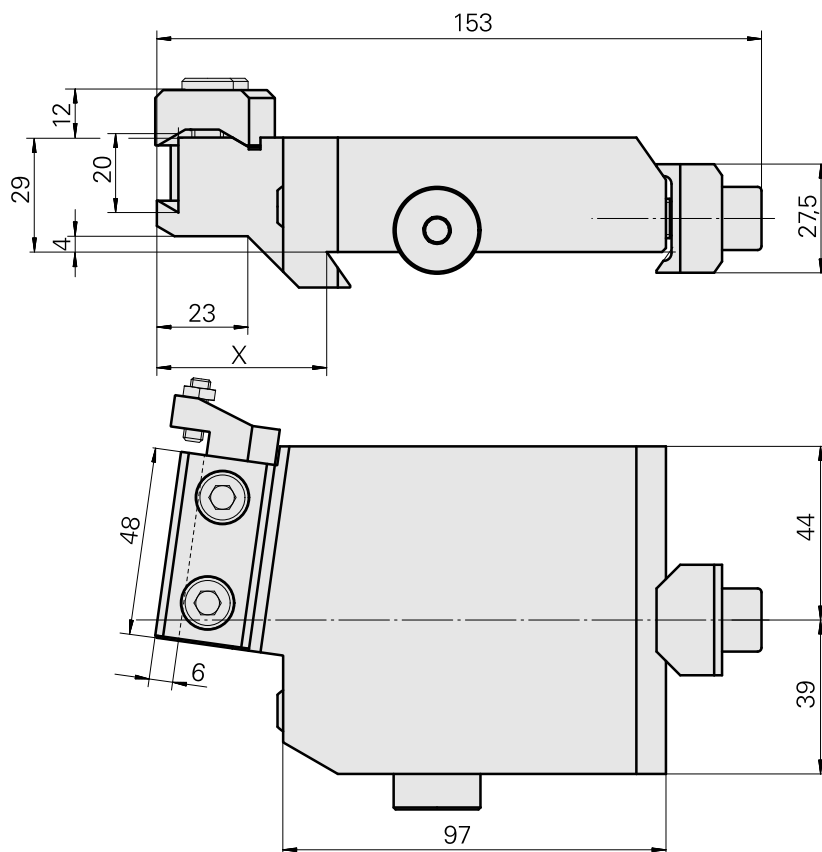
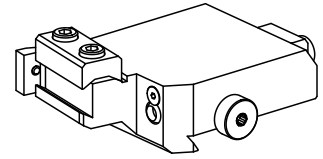

X	43
---	----

Documents

No downloads available for this product

Accessories

Optional accessories

Other accessories

[Tube Kugel 12 D](#)

Product ID : 10481964

Previous product ID : W63490.0022

[Countersunk screw 8.8 Torx M 5x12 14581 M 5x12/T25 verzinkt 402315 12](#)

Product ID : 10607371

Previous product ID : 410362.0512
