

## WFB 32-20 Milling shaft D27

### Technical data

TH accessories category

WFB 32-20

Mounting

Milling shaft D27

Quick change inserts

mill arbor mounting

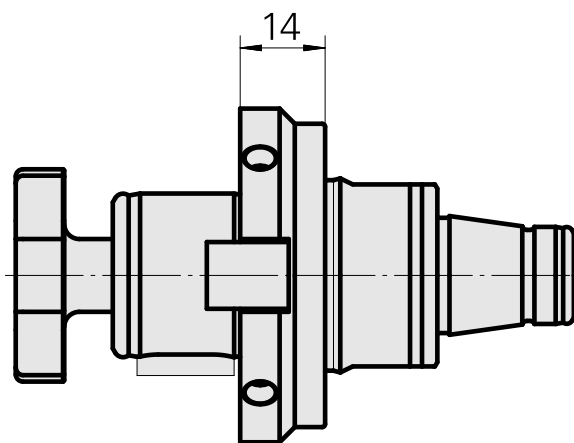
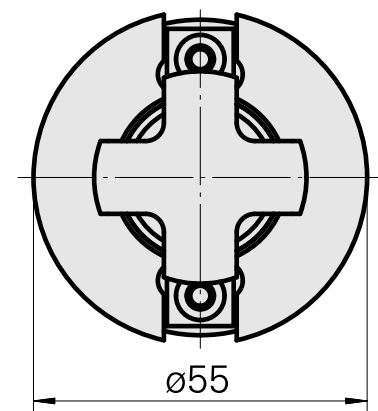
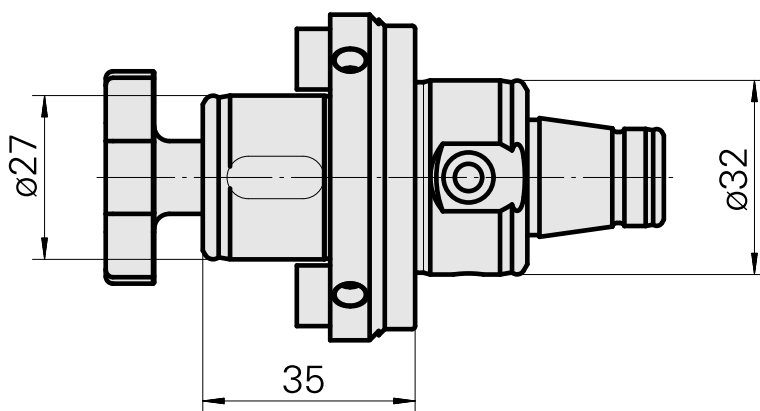
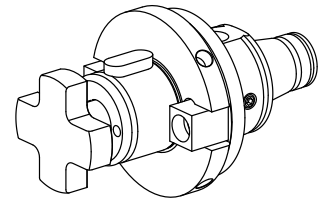

---

## Documents

No downloads available for this product

## Accessories

Required for operation

### [mill arbor wrench](#)

Product ID : 10860744

Previous product ID : 203020.1270

TH accessories  
category  
Tool

Mounting  
Milling shaft D27

Tools for Collet chucks  
Mill arbor wrench

### Optional accessories

#### Tool holder accessories

### [Screw](#)

Product ID : 10085152

Previous product ID : 250122.1235

TH accessories  
category  
Cutter tightening screw

Mounting  
M12

#### Other accessories

### [Ring](#)

Product ID : 10398855

Previous product ID : 251390.----

---

### [Ring](#)

Product ID : 10169490

Previous product ID : 251391.----

---