

## Drilling tool holder HSK 40 A DIN 1835 B

### Technical data

Shank HSK	HSK 40
Form HSK	A
Mounting	DIN 1835 B/E D10
Cooling	internal
Pressure	80 bar
X [mm]	45.5 (1.79")
INDEX TRAUB products	G160 • V100 • G200.2 • G220 • R200 • TNX65/42 • G220.3 • TNX220.3

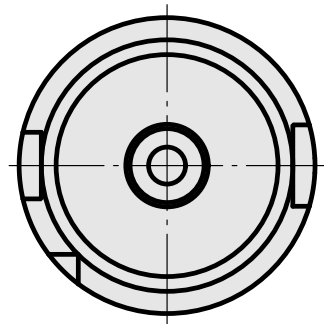
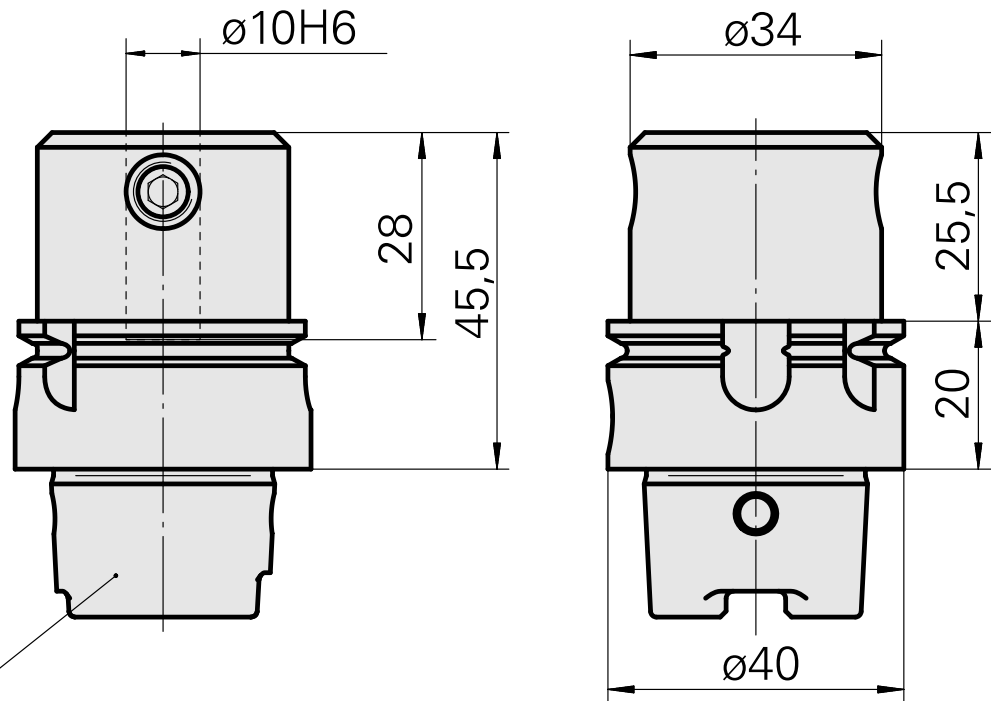
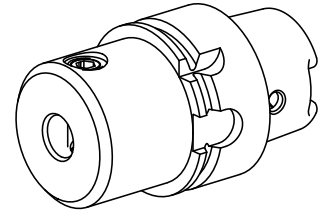

---

## Documents

No downloads available for this product

## Accessories

Required for operation

### [Socket wrench](#)

Product ID : 10532354

Previous product ID : WS7400.0010

TH accessories  
category  
Tool for KSS adapter

Mounting  
HSK 40 A/C

Optional accessories

### **Tool holder accessories**

### [Coolant adapter kit](#)

Product ID : 10581780

Previous product ID : WS7400.0020

TH accessories  
category  
Cooling lubricant  
transfer set

Mounting  
HSK 40 A/C

### [Coolant supply, max. 120 bar](#)

Product ID : 12024083

Previous product ID :

TH accessories  
category  
Cooling lubricant  
transfer set

Mounting  
HSK 40 A/C