

ER-Collet chuck for taps ET 1-20 3.55mm

Technical data

TH accessories category	ER-Collet chuck for taps
Mounting	ER20
Tool mounting	3.55mm
Collet type	ET 1-20

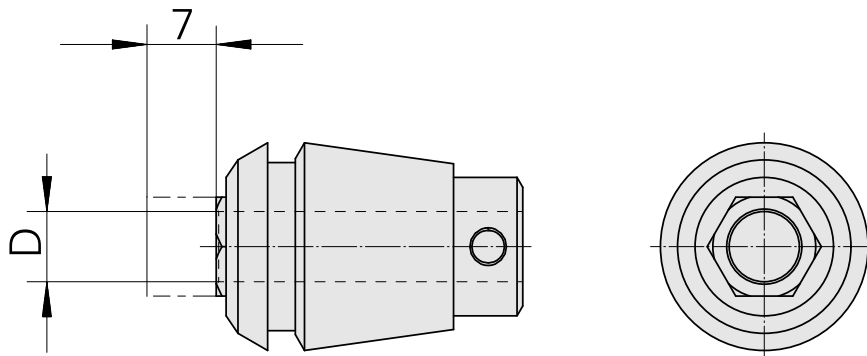
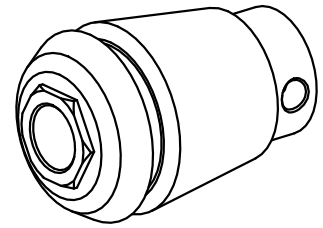

10316524
323443

INDEX

Documents

No downloads available for this product