

WFB 32-20 Shrink-fit mounting D8

Technical data

TH accessories category

WFB 32-20

Mounting

Shrink-fit mounting D8

Quick change inserts

shrink-fit mounting

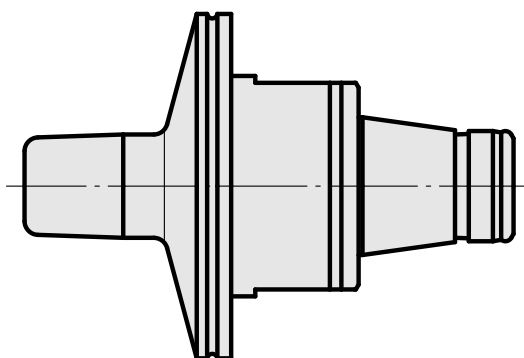
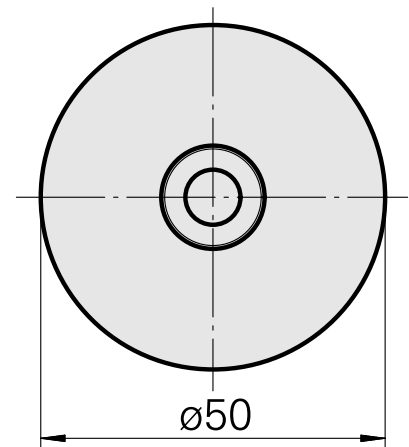
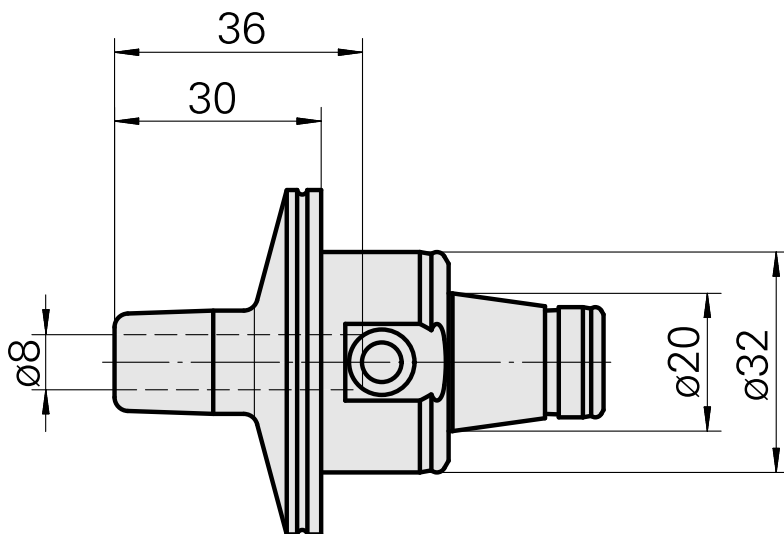
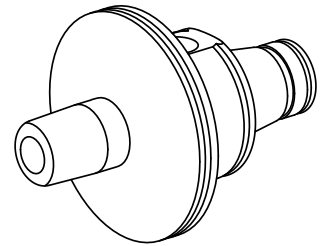

10915140
836263

INDEX

Documents

No downloads available for this product