

## WFB 32-20 D8

### Technical data

TH accessories category

WFB 32-20

Mounting

D8

Quick change inserts

Weldon mounting

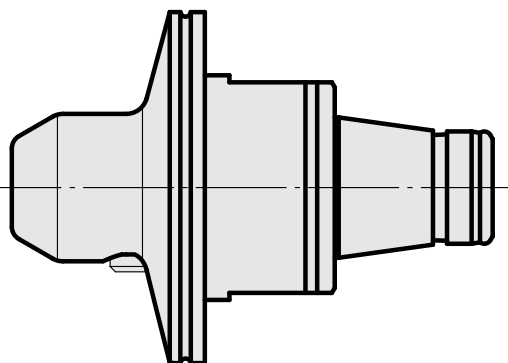
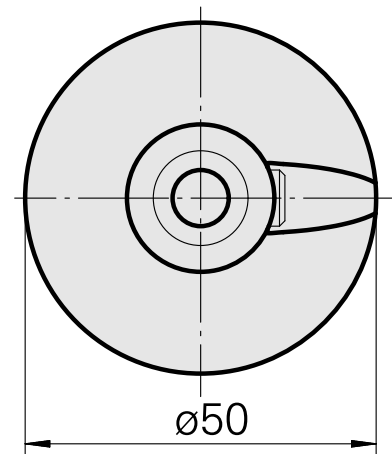
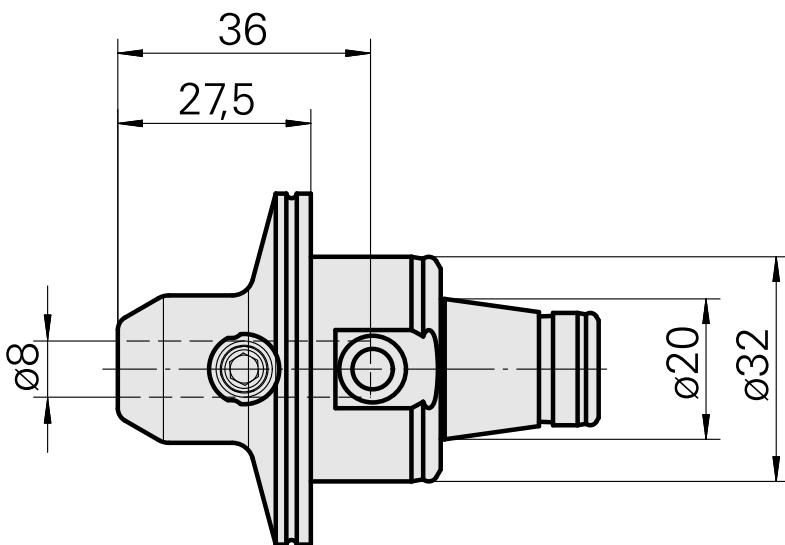

10851486  
836271

**INDEX**

---

## **Documents**

No downloads available for this product