

ER-Collet chuck for taps ET 1-25 5.6mm

Technical data

| | |
|-------------------------|--------------------------|
| TH accessories category | ER-Collet chuck for taps |
| Mounting | ER25 |
| Tool mounting | 5.6mm |
| Collet type | ET 1-25 |

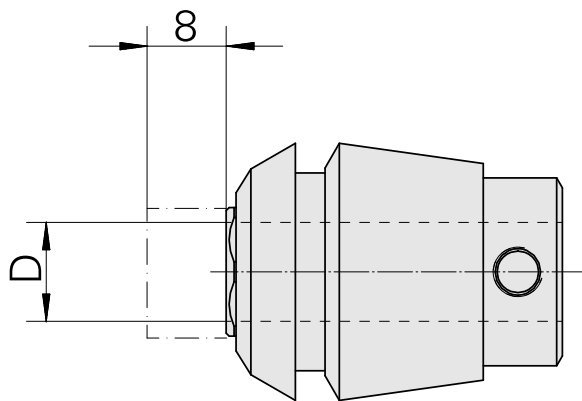

10673937
322462

INDEX

Documents

No downloads available for this product