

Turning tool holder HSK 40 T square 20x2

Technical data

Shank HSK	HSK 40
Form HSK	T
Mounting	Square 20x20
Cooling	external
Pressure	50 bar
X [mm]	80 (3.15")
Z [mm]	30 (1.18)
INDEX TRAUB products	G220.3 • G220 • R200 • TNX220.3

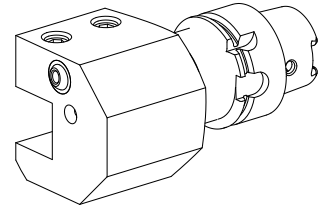

Note

Not suitable for INDEX G160, G250 and G400! Adjacent stations in the tool magazine can only be used to a limited extent!

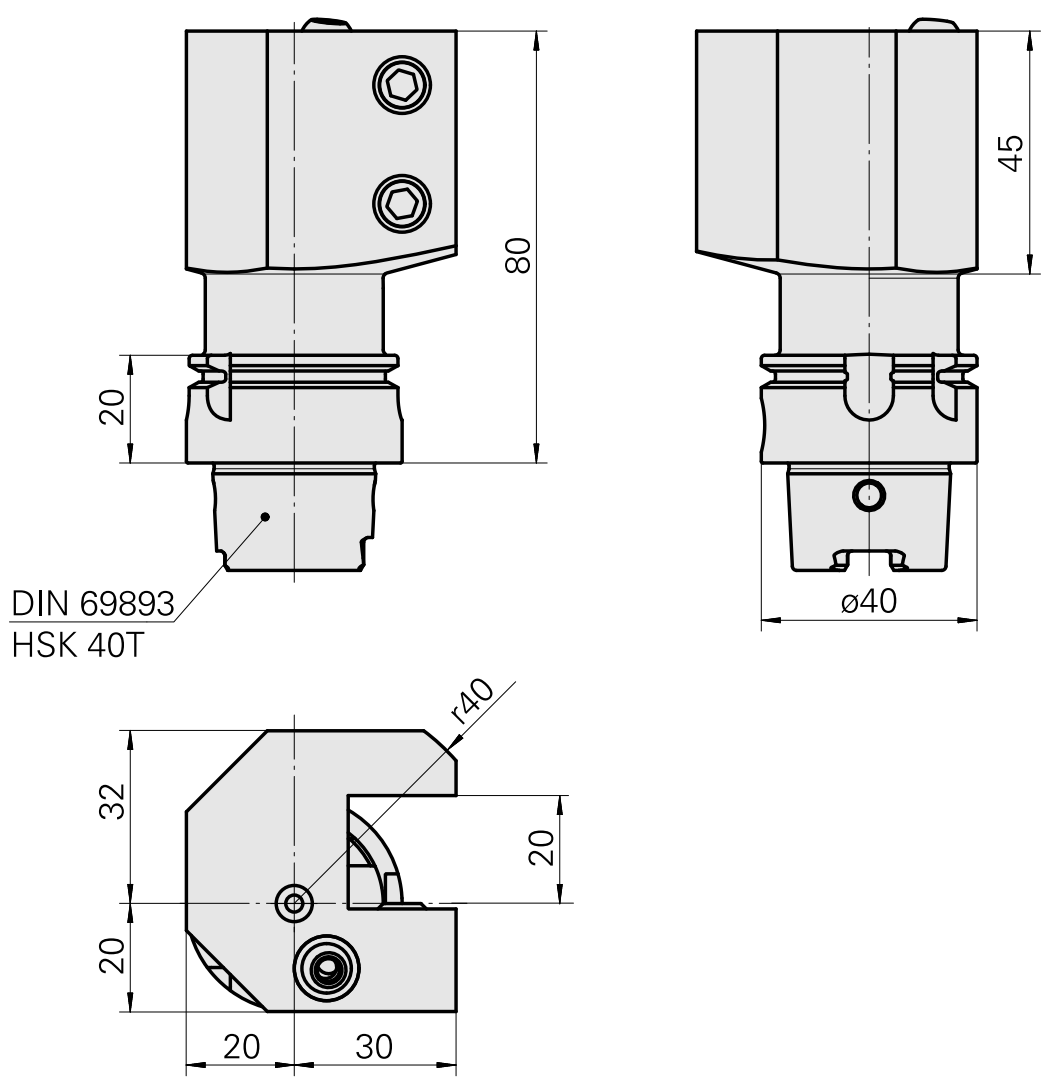

Documents

No downloads available for this product

Accessories

Required for operation

[Socket wrench](#)

Product ID : 10532354

Previous product ID : WS7400.0010

TH accessories
category
Tool for KSS adapter

Mounting
HSK 40 A/C

Optional accessories

Tool holder accessories

[Coolant adapter kit](#)

Product ID : 10581780

Previous product ID : WS7400.0020

TH accessories
category
Cooling lubricant
transfer set

Mounting
HSK 40 A/C

[Coolant supply, max. 120 bar](#)

Product ID : 12024083

Previous product ID :

TH accessories
category
Cooling lubricant
transfer set

Mounting
HSK 40 A/C

[Angle, height 8 mm \(0.31"\), width 8 mm \(0.31"\)](#)

Product ID : 10271441

Previous product ID : W63300.0010

TH accessories
category
Compensation bracket

Mounting
Square 20x20

[Angle, Height 4 mm, Width 4 mm](#)

Product ID : 10135472

Previous product ID : W63300.0020

TH accessories
category
Compensation bracket

Mounting
Square 20x20